



SEALING TECHNOLOGY MANUAL FOR THE PROCESS INDUSTRY

FREUDENBERG
SEALING TECHNOLOGIES

 **FREUDENBERG**
INNOVATING TOGETHER

TABLE OF CONTENTS

1	INTRODUCTION	4
1.1	Company	4
1.2	Market-specific services	6
	Freudenberg Xpress	6
	Product marking technology	7
	Test facility	8
	Damage analysis	10
	Washing and individual packaging	12
	Collaboration with associations	13
1.3	The process industry and its requirements	14
	Food industry	14
	Pharmaceutical industry	16
	Chemical industry	18
<hr/>		
2	TECHNICAL FUNDAMENTALS	20
	Basic materials testing	21
	Storage conditions	25
	Approvals, examinations, compliances	26
	Hygienic design	28
	Friction optimization	29
<hr/>		
3	ELASTOMERIC MATERIALS	31
	Overview of elastomeric materials	32
	EPDM	34
	VMQ	36
	NBR	37
	HNBR	38
	FKM	40
	Simriz®	42
	Fluoroprene® XP	44

4	ENGINEERING PLASTICS	47
	Overview of engineering plastics	48
	PTFE	49
	ePTFE	51
	POM, PA, PU, PEEK	52
<hr/>		
5	MATERIALS RESISTANCE AND PURITY	54
	Temperature and fat resistance	55
	Flavoring agents	57
	Cleaning process	60
	Extractables	61
	Hygienic design	63
	Storage tests	64
<hr/>		
6	PRODUCT PORTFOLIO	65
	O-rings	66
	Encapsulated O-rings	68
	Seals for pipe connections	70
	Diaphragms	74
	Hygienic Usit rings	75
	Rotary shaft seals	76
	V-Seal set packings	78
	Stuffing box packings	80
	Precision molded parts	82
	Butterfly valve seals	84
	Low pressure profiles	86
	Guide strips	87
	PTFE bellows	88
	PTFE U-packings	89
<hr/>		
7	APPENDIX	91
	List of abbreviations	92
	General installation and assembly instructions	94
	Legal notices	95

COMPANY



The Freudenberg group of companies was founded in 1849 and is still family-owned. The resulting financial stability and social awareness are key success factors that create trust.

Today, Freudenberg is a global, broadly-diversified group. While Freudenberg & Co. KG represents the strategic lead company, Freudenberg SE as the operational holding company reflects the global nature of the Group of companies.

Freudenberg is divided into business groups which operate in different industries. From household products of the Vileda® brand to technically com-

plex sealing solutions, the company is always considered an innovation and technology leader. Thus, for example, the famous Simmerring® is a Freudenberg invention dating back to 1929, which is still being used in many industries and a wide variety of applications today.

The pronounced segmentation of the Group has only one goal: to be close to the customer and to meet the requirements of a market specialist. Numerous research and development facilities ensure the long-term success of the company and allow a rapid response to market- and customer-specific transformations.

Freudenberg Sealing Technologies is the largest business group of the Freudenberg Group and belongs to the business area Seals and Vibration Control Technology. Together with the partners of NOK Corporation, the company forms a network with the aim of offering local products of uniform quality worldwide. This concept is supported by global manufacturing, innovation, occupational health and safety and quality management strategies.

Freudenberg Sealing Technologies is organizationally divided into independently operating market segments. This ensures that the respective industry sectors are managed by specialized know-how carriers. From the standard seal to the tailor-made precision molded part, Freudenberg Sealing Technologies offers a unique product range in all segments. The basis of its success are the highly-developed proprietary materials and products.

Sealing solutions specially developed for the process industry in accordance with hygienic design and materials with industry-specific approvals such as FDA or USP Class VI, as well as a comprehensive resistance database make Freudenberg Sealing Technologies the technology leader in this industry. As a technology leader, we want to provide our customers with exceptional quality at all times and develop the sealing solutions of tomorrow together with them. We invest in innovation and partnership and thus ensure our longterm success.

Quality management

We not only enhance our products continuously, we also work on the continuous improvement of our internal processes – with only one goal: to provide our customers with consistent quality. Therefore we are certified according to ISO 9001.

The certification is valid for the following areas:

- Sale of sealing products
- Technical advice for sealing products
- Provision of services involving seals, in particular the optimization of the supply system

Certification is intended to give our customers confidence. Because quality can only be guaranteed if the internal processes are performed in a standardized structured and replicable manner. From the preparation of a quote to the packaging of individual O-rings, we have established streamlined processes and constantly strive for further improvement.

Our zero-defect policy motivates all our employees to excellence and top achievements. Moreover, our quality management and application support are readily available in the event of technical problems.



MARKET-SPECIFIC SERVICES

FREUDENBERG XPRESS

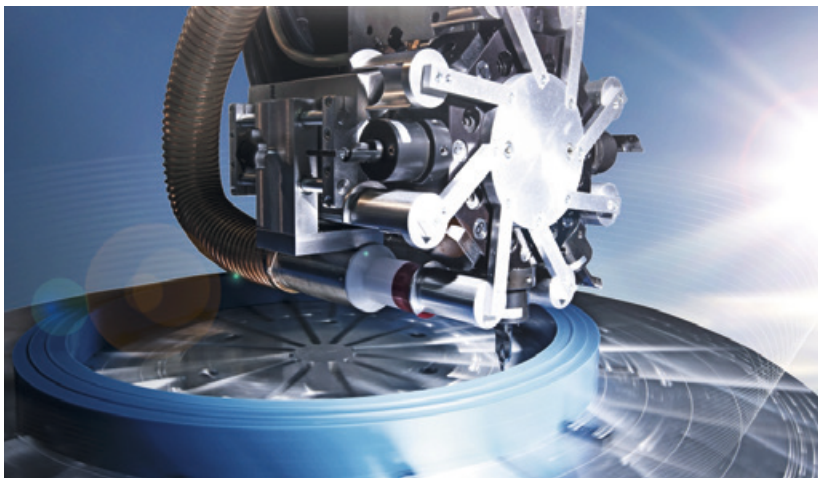

The Freudenberg Xpress service can provide seals in original quality within a few hours using the latest CNC technology. Freudenberg Xpress is the best choice not only for the quick delivery of replacement parts, but also for the economic production of small series.

Thanks to state-of-the-art manufacturing facilities and in-house machining tools development, Freudenberg has achieved a unique surface quality with a mean roughness index of max. $R_a = 2.38 \mu\text{m}$ (roughness depth $R_t = 13.7 \mu\text{m}$). This value is approximately equal to that of a conventionally produced seal. You can find an overview of materials suitable for machining technology on page 32 f.

The lip edge is created by cutting, which is a complex process and therefore rarely applied in the market. The machined seals of Freudenberg achieve an exceptionally long service life.

Delivery of replacement parts in record time

When a seal fails during the production process and a replacement part is not in stock, every hour counts in order to prevent costly machine downtime. Freudenberg Xpress can normally find a remedy within 24 hours. On the basis of a drawing or a sample, the seal can be machined and sent without detours directly to the location where it is required.

Rapid prototyping

The term “rapid prototyping”, i.e. the rapid production of functional models, is in actual fact not applicable to elastomer technology. Nevertheless, the specialists at Freudenberg make exactly this possible. Thanks to the production of prototypes without standard tools, sample parts can be created that can be tested and optimized until the best solution has been found. This reduces the development time of new plants while minimizing the financial outlay.

Economical short runs

Machining technology cannot be a production method equivalent to series production. From a certain annual quantity, the investment in mass production tools becomes worthwhile from an economic point of view. However, by temporarily switching to machining technology, small batches can be processed, the manufacturing time of mass production tools can be bridged, and market fluctuations with stagnating demand can be responded to.

THE ADVANTAGES AT A GLANCE

- Production of prototypes to shorten the development time
- Fast remedy in the event of defects
- Economic production of small batches without series production tools
- Original Freudenberg materials with approvals such as 3-A® Sanitary Standards and USP Class VI, as well as FDA conformity
- Almost the same mechanical properties as those of mass-produced seals
- Unique surface quality
- Long service lives

MARKET-SPECIFIC SERVICES

PRODUCT MARKING TECHNOLOGY

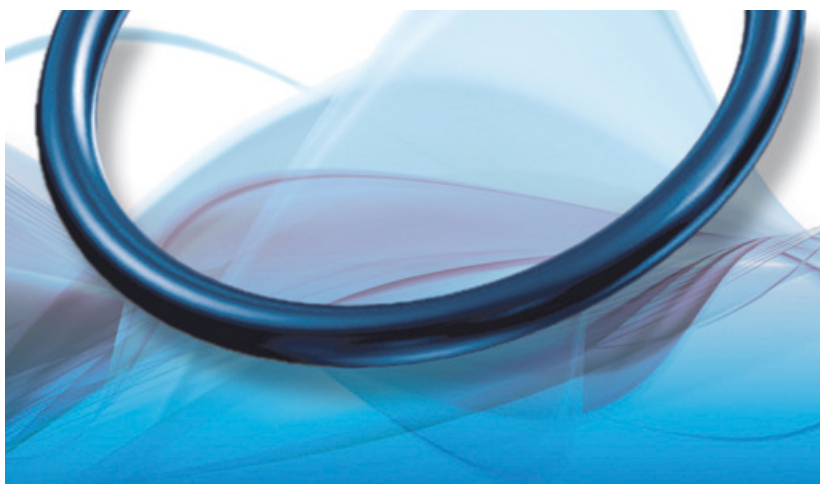

Freudenberg's patented laser marking technology "safe" (secure adaptive freudenberg encryption) offers the highest application security through identification and traceability of seals.

High material purity, reliable media and temperature resistance, as well as various statutory requirements with respect to sealing components characterize the process industry. Only quality products designed for this meet the expectations in terms of smooth production workflows. Freudenberg product marking technology gives plant operators the certainty of using original quality according to individual stipulations, of preventing the use of unverifiable knock-offs and of ensuring complete traceability of the component used.

Unmistakable seals

The safe technology identifies seal components by means of a patented laser marking, among other things, in a forgery-proof manner with a 24-digit encrypted code. This code contains information about article, batch and serial numbers, date of manufacture, in-

dividually definable customer-specific application and approval information. The readout is simple and reliable with the help of a readout device, our security software and a commercially available notebook computer. The unique aspect here is this: The product markings can still be decrypted thanks to the high redundancy of the code even when up to 60% of the identification marking is destroyed. In addition, the product markings are also outstandingly protected by their topography against mechanical and chemical influences.

"safe" offers the significant added value that the risk of process disruptions caused by seals is minimized. Mix-ups of materials can be excluded and documentation requirements can be satisfied much more easily. Promises of guarantee are safeguarded and unjustified warranty claims are averted. With regard to the marking process, Freudenberg has consistently taken the requirements for contamination-free components into account.

FDA-compliant and hygienic

With the laser marking, Freudenberg abstains from the admixture of marker substances or components and thus avoids interfering with conformities like FDA or USP Class VI of the sealing material used. Also unproblematic for hygienic applications is the coding depth of the laser marking. For this, Freudenberg has carried out extensive testing of marked seals in accordance with EHEDG guidelines (European Hygienic Engineering and Design). The code structures affect neither the cleanability nor the risk of microbial contamination, for example in the case of a bottling plant.

THE ADVANTAGES AT A GLANCE

- Unique laser marking system for easy and economical identification and traceability
- Forgery-proof technology to protect against product piracy
- Traceability of article, batch and serial numbers, date of manufacture, materials, dimensions and design details
- High readout reliability even with damaged codes
- Protection against product mix-ups
- Safeguarding of guarantee promises and protection against warranty claims
- FDA-compliant

MARKET-SPECIFIC SERVICES

TEST FACILITY

The Freudenberg test facility offers new validation options for the perfect adjustment of seals to the respective CIP/SIP (Cleaning In Place/Sterilization In Place) process.

CIP/SIP and superheated steam processes are an integral part of production in the process industry. Cleaning agents and heat put significant stress on the seals, which is a critical factor for smooth workflows if the seal was badly configured here with respect to material and design.

Freudenberg's test plant allows meaningful seal tests in all standard CIP/SIP media as well as in steam and hot wa-

ter under real conditions. From the O-ring to the butterfly valve seal, verified statements on the functionality of the seal used can thus be derived even prior to serial use.

A proactive development partnership, which significantly increases the reliability and thus the cost effectiveness of valves and customer-specific systems.

The system design

The test plant is designed as a multi-tank CIP system and thus offers the possibility to demonstrate different cleaning processes with acids, alkaline solutions and disinfectants. The core of the system is formed by three test

tracks in which three valves are tested in parallel or in series. The operating parameters such as temperature, pressure and flow rate are recorded digitally. For intentional contamination of the valves, a container can be filled with the medium used in the application. In order to create realistic test conditions, customizations to the fittings and assemblies can also be carried out easily. On this basis, meaningful test results can be obtained with respect to service life, resistance or necessary design optimization of a seal. This is valuable information in order to make the right decisions as early as during the conceptual sealing design of the system.

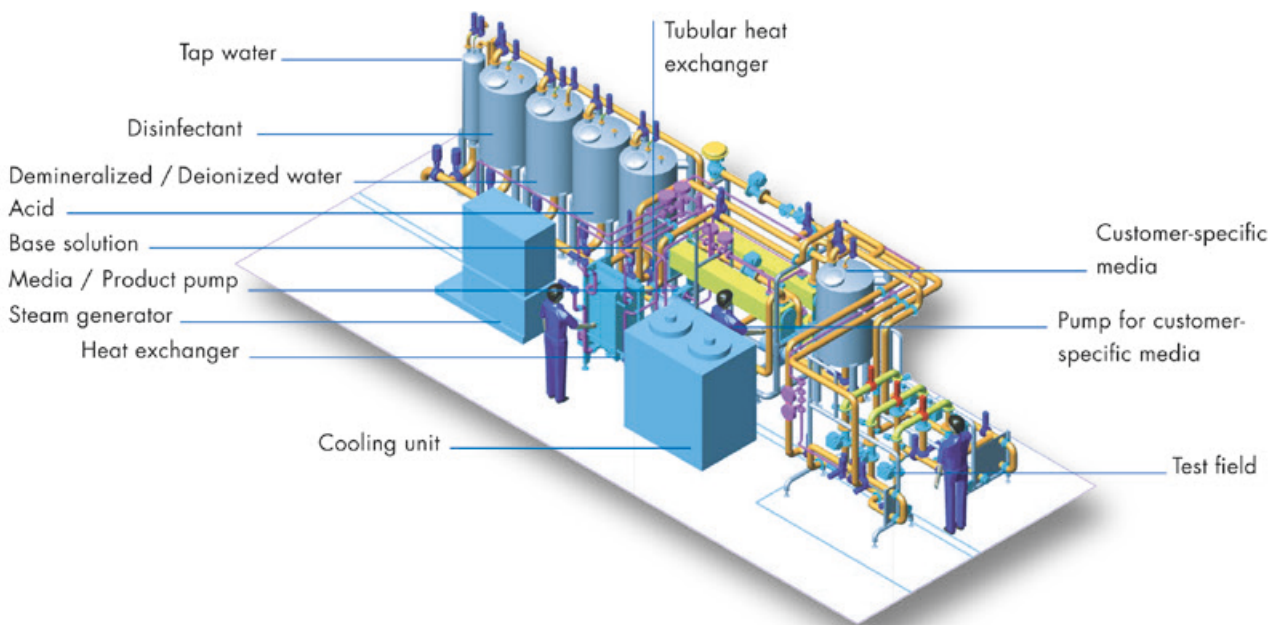



Test methods and possibilities

- Sealing tests in conjunction with acids, alkaline solutions and disinfectants
- Separate media supply for valve and seal contamination
- Testing of critical applications with superheated steam, cooling water and compressed air supply
- Testing of all types of seals in fittings and equipment assemblies, such as O-rings, diaphragms, butterfly valve seals and gaskets as well as molded parts
- Testing of measurement instrumentation and pump seals
- Damage analysis in the event of leakage
- Reliable compatibility recommendations concerning seals and process media

THE ADVANTAGES AT A GLANCE

- Demonstration of customized CIP/SIP processes under real operating conditions
- Verified statements concerning resistances and reliability of material and seal design
- Validation of the seal selection prior to the start of series production
- High operational reliability throughout the product life cycle
- More efficient production processes
- Avoidance of time-consuming and cost-intensive field tests

Examples of possible testing cycles

CIP/SIP MEDIA	CONCENTRATION RANGE (%)	RESIDENCE TIME (MIN.)	TEMPERATURE RANGE
Acidic cleaning agents e.g. on the basis of HNO_3	0.5 to 3.0	20 to 30	+30 to +80 °C (+86 to +176 °F)
Alkaline cleaning agents e.g. on the basis of NaOH	2.0 to 3.0	20 to 120	+30 to +80 °C (+86 to +176 °F)
Disinfectants e.g. on the basis of H_2O_2	0.3 to 1.0	30 to 60	+25 °C (+77 °F)
Acidic disinfectants e.g. on the basis of H_2O_2 and HNO_3	0.5 to 1.0	20	+25 °C (+77 °F)
Alkaline disinfectants e.g. on the basis of H_2O_2 and NaOH	H_2O_2 : 0.5 NaOH: 1.0 to 2.0	30	+80 °C (+176 °F)
Sterilization with steam	100.0	20 to 45	+120 to +140 °C (+248 to +284 °F)

MARKET-SPECIFIC SERVICES

DAMAGE ANALYSIS

Seals may be damaged in several ways. Damage is often caused by changes in the process media and the fact that their effects on the seal materials were not taken into account in advance.

After an incident, it is essential to find out the cause in order to prevent subsequent damage and to find the right seal for the individual application. Freudenberg's application support creates meaningful damage analyses and helps you fix the problem. When a case of damage occurs, the following documentation has to be carried out.

How should seal damage be documented?

- Take photographs of the installed seals using the maximum resolution possible

- Indicate self-inflicted damage (e.g. by using a screwdriver during the removal)
- Give the exact installation location: valve number, component etc.
- Observe mating surfaces and grooves (condition, roughness, deposits etc.) and document changes

Which media have contact with the seal and what are the circumstances?

- **Products:**
 - Ingredients
 - Pressures
 - Temperatures
 - Concentrations
 - If possible, obtain the safety data sheets

- **Flavoring agents:**
 - If samples are allowed to be taken, they should be filled into glass bottles
 - Listing of the flavors, which are in direct contact with the seal
- **Cleaning media:**
 - Media sequence
 - Pressures
 - Temperatures
 - Concentrations of the cleaning agents and frequency of cleaning
 - If possible, obtain the safety data sheets

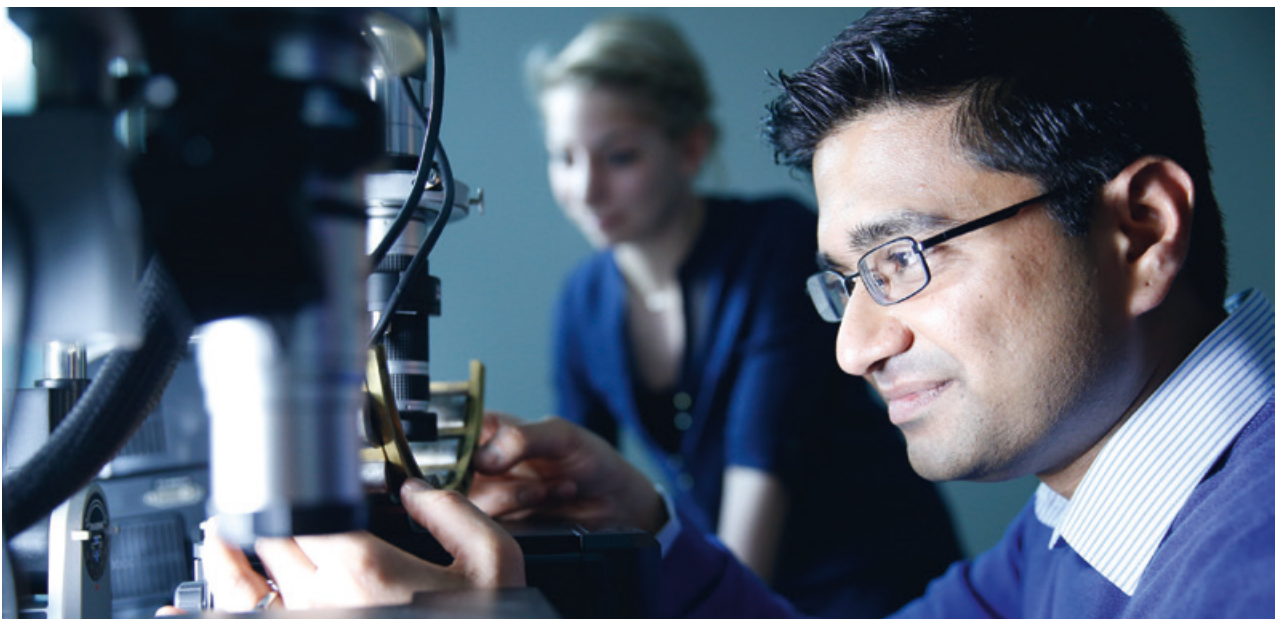

Typical cases of O-ring damage



Twisting during installation – Large O-rings with a small cross-section are not very dimensionally stable and can be twisted when mounted. After removal, a circumferential track in the elastomer is visible in case of heavy strain and wear. If one puts the O-ring on a flat surface, a permanent deformation can be noticed as a twist. The use of an assembly grease suitable for the material and great care during the installation of O-rings with an unfavorable cross-section to diameter ratio is recommended.

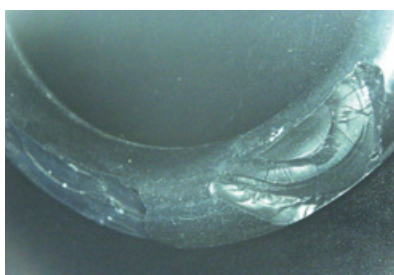

Grease swelling – EPDM swells in mineral oil and mineral fat and becomes softer. The damage is evident in shell-like disruptions with relatively round edges. Even individual pieces can break off. It is necessary to check whether the correct assembly grease was used. Generally, EPDM may only be lubricated with silicone grease. In addition, the product-specific information, such as fat concentration, temperature etc., should be recorded in order to verify the possibility of using EPDM.

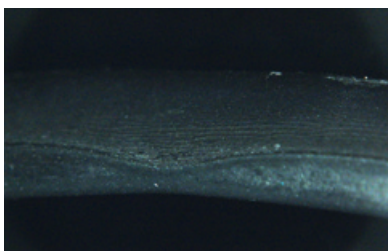

Failure due to excessive friction – The elastomer “scrapes” by friction on the opposite surface, whereby particles are abraded. Depending on the type of surface, one can observe different damage patterns. To remedy the situation, the condition of the opposite surface should be thoroughly investigated and the product and purity parameters should be documented.

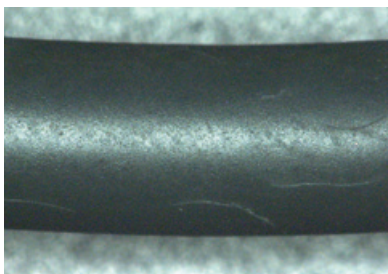

Explosive decompression – Cracks in longitudinal directions can be found on the surface. The elastomer saturates itself with gas under pressure. When rapid depressurization occurs, the amount of gas cannot escape fast enough from the matrix of the elastomer and forms gas bubbles (similar to diver’s paralysis/aeroembolism).

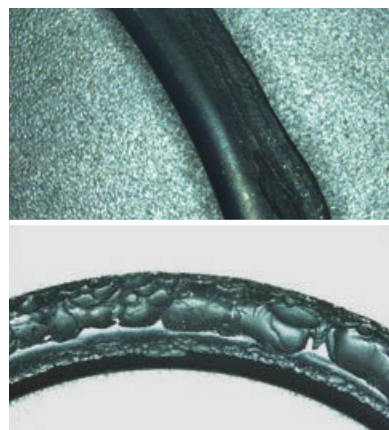

Gap extrusion – Provided that the design is consistent, the factors which can push the O-ring into a gap and lead to a shearing-off include varying pressures, dynamic stress and media expansion. Depending on the individual case, there are diverse manifestations, as shown in the sample illustrations above. With dynamically stressed seals, one colloquially refers to “mouse nibbling” in the event of damage.

Image above: Gap extrusion in static application

Image below: Gap extrusion in dynamic application

MARKET-SPECIFIC SERVICES

WASHING AND INDIVIDUAL PACKAGING

For particularly hygienic applications, we offer our customers a washing service. It includes thorough, reliable cleaning of seals after production, so that even the smallest impurities or particles are removed. In order to protect the purity, we recommend subsequent individual packaging.

Especially when seals are not immediately installed, but put into storage, contamination can occur which may then be introduced into the process. Freudenberg offers the possibility to create custom packaging. For example, we provide the bags with logo, article and batch numbers and other individual information. Thus, the individual package not only fulfills the purpose of protection against soiling and contamination, but also helps to track components up to the seal and thus comply with the prescribed documentation requirements.

Furthermore, Freudenberg provides the option to apply a removable label with customer-specific information on the package which can be pasted into the service manual. This allows for comprehensive and continuous documentation.

For an OEM (Original Equipment Manufacturer), the individual packaging has another important advantage. When seals are resold to MRO customers (Maintenance, Repair and Operations), they do not need to be repackaged. Depending on the order quantity, the individually packaged seals can be combined in one shipment.

THE ADVANTAGES AT A GLANCE

- Washing service for hygienically demanding applications
- Secure traceability to the point of the individual seal thanks to single-unit packaging
- Rapid identification of individually wrapped seals
- Removable labels for easy transfer of the information into the service manual, to ensure comprehensive traceability

MARKET-SPECIFIC SERVICES

COLLABORATION WITH ASSOCIATIONS



Freudenberg's commitment to cooperation with associations is an essential basis of its market specialization, in order to be able to turn trends and developments into industry-specific solutions at an early stage. Freudenberg Sealing Technologies is an active member in the following associations amongst others.

ASME (American Society of Mechanical Engineers)

ASME is an American non-profit organization that has set itself the goal of being a platform for engineers. The ASME has about 130,000 members in 158 countries worldwide and invests heavily in education, which is why a large proportion of members are students. ASME is divided into many specific groups such as Manufacturing and Processing, Automotive and Bioengineering, thus enabling exchanges between professionals.

DIN (Deutsches Institut für Normung [German Institute for Standardization]) DIN develops standards as a service to industry, government and society. It is a private enterprise institution with the legal status of a non-profit organ-

ization. The main task of DIN is the development of consensus-based standards, together with the representatives of interested stakeholders, in line with the times and with the market. About 26,000 experts contribute their know-how to the work of creating generally accepted standards. Due to a contract with the Federal Republic of Germany, DIN is recognized as a national organization in European and international standards organizations. Today, about 90% of the work of DIN has an international outlook and orientation.

EHEDG (European Hygienic Engineering and Design Group)

The EHEDG is an interest group for operators and suppliers of equipment for the production of foodstuffs as well as for testing institutes and maintenance companies. More than 300 member companies participate in the EHEDG. This gives rise to wide support and sound instructions for all aspects of hygienic design and manufacture of machinery, and equipment for the production of safe food and pharmaceuticals.

ISBT (International Society for Beverage Technologists)

The ISBT is an American organization which consists of about 1,000 members worldwide. The focus of its activity is the beverage industry and it offers this industry a highly specialized platform which concerns itself with flavor transfer, packaging, ingredients and other current trends.

ISPE (International Society for Pharmaceutical Engineering)

The ISPE is the world's largest non-profit organization for the advancement of the pharmaceutical industry and the continuing education of its employees. Founded in 1980, it now has more than 25,000 members in 90 countries. The ISPE is an independent organization, led by experienced professionals from prestigious companies in the pharmaceutical industry. It provides a forum for experts from industry and government, independent consultants and students.

VDMA (Verband Deutscher Maschinen- und Anlagenbau [German Engineering Association])

The VDMA is one of the leading service providers offering the largest industry network of the capital goods industry in Europe. The VDMA represents about 3,100 mainly medium-sized member companies, making it one of the leading industrial associations in Europe with one of the largest memberships. The VDMA covers the entire process chain – everything from components to entire plants, from system suppliers and system integrators to service providers. The VDMA thus facilitates both industry-specific and intersectoral cooperation.

THE PROCESS INDUSTRY AND ITS REQUIREMENTS

FOOD INDUSTRY

The diversity of the food industry requires separate consideration of the different areas, since the respective requirements are as varied as they are numerous.

Beer

Hygiene and cleanliness of the production facilities as well as a variety of other challenging factors require a precisely matched sealing technology in the production of beer. In addition to the sometimes aggressive cleaning processes, the sealing materials must withstand salt deposits (beer scale) and tolerate a high CO₂ content. The preferred cleaning method uses acid at a concentration of up to 3% at +80 °C (+176 °F) in order to remove the salt deposits from the pipe system. During production and cleaning (steam steri-

lization), high temperatures prevail, which present a major thermal load for seals. Ultimately, the wort also promotes a high degree of wear of the seals. For this reason, the sealing material for this application should be carefully selected.

Non-alcoholic beverages

While alcoholic and carbonated drinks stabilize themselves due to their ingredients, still waters are highly sensitive products whose production process requires great attention with respect to hygiene and cleanliness. Because of the use of strong cleaning media in the production of fruit juice and because of flavor-containing additives, it is not possible to use just any elastomer or plastic material.

Dairy products

In the dairy industry, influences such as a high fat content of the product media must be taken into account in the selection of materials. An EPDM material which has a very good resistance to CIP/SIP media, for example, has only limited resistance to fatty media. Cleaning with alkaline solution is also carried out very intensively, i.e. at high concentrations and temperatures, in order to eliminate the fat and protein residues from the pipes. Steam sterilization methods are also to some extent used much more intensively in dairies than for instance in breweries. The seals must be designed accordingly for this.

**Jam**

In the manufacture of jams and preserves, pieces of fruit and crystallization of sugar lead to increased wear. Fruit particles can be pressed into the seal and cause leakage in extreme cases. The sealing material used here must be resistant to the fat- and flavor-containing additives and to the partly aggressive cleaning agents.

Convenience foods

Different cleaning media for closed and open processes greatly stress seals in the production of ready-made meals, such as frozen pizza. The production of powders, pastes, liquids etc. requires individual demands on the sealing materials. For some convenience foods, excellent low-temperature flexibility is also required, which cannot be met by every seal material in combination with the chemical resistance.

Chocolate

Chocolate production and processing is a particular challenge for seals. The ingredients themselves are challenging because it is a medium containing fat, which may also contain additives such as nuts, raisins or crisps, causing severe abrasion. This is further increased when crystallization of the sugar occurs during the manufacturing process. Additives containing flavoring agents are also an exclusion criterion for some materials. Then the temperatures must be taken into account, some of which are very high in chocolate production in order to make the ingredients capable of being processed. The sealing material must meet all of these requirements.

Ice cream

The threat to the sealing material in the manufacture of ice cream consists, firstly, of the high fat content of the ice cream mixture, and secondly, of additives such as pieces of fruit which may press themselves into the seal and cause leakage. Large temperature ranges, e.g. from 0 °C (+32 °F) during the transportation of a cold product up to +140 °C (+284 °F) during steam sterilization, must be mastered reliably by the seal. Aside from that, resistance to CIP/SIP media should also be given.

THE PROCESS INDUSTRY AND ITS REQUIREMENTS

PHARMACEUTICAL INDUSTRY

The purity requirements with respect to processes and products in the pharmaceutical industry require sealing solutions that reliably prevent process contamination, beyond their respective media resistance.

Freudenberg has developed special materials and seals, such as white EPDM and Simriz® (FFKM), which comprehensively satisfy both the demanding operating conditions and simultaneously support the hygienic processes.

In the pharmaceutical industry, the synthesis of products takes place from basic chemicals. The basic and reactive chemicals need to be extra pure so that no unwanted by-products are generated in the synthesis. In general, production is done in batches in order to ensure traceability from the raw

material supplier to the patient in the event of quality problems. Seals are a not to be underestimated part in this process because they partly have direct contact with the media. And with the appropriate sealing technology, the risk of contamination and thus of costly and time-consuming retracing can be reduced.

A particular challenge for this industry lies in the versatility of its processes where many different demands are made on the components. To illustrate this, three areas and their peculiarities are presented in this context.

Production of finished medicinal products

During the production of chemically produced drugs API (Active Pharmaceutical Ingredients) or in vivo diagnostics (contrast agents, biomarkers), chemicals and toxic substances are used. During organic synthesis, high temperatures and high pressures occur, whereas cooling takes place during the precipitation of the product. The temperature range is correspondingly quite large. To ensure the hygiene and purity of a batch, special attention must be paid to the documentation of the processes. Thus, the ingredients of the sealing materials must be known too, or appropriate confirmation of biocompatibility according to USP Chapter 88 (Class VI) must be available.



In galenics (pharmaceutical technology), the medicinal product receives its form. For example in this step a tablet is pressed and coated so that the medication can be taken. Before a tablet can be pressed, the active ingredients and excipients must be manufactured according to the recipe, wet granulated, and then dried and ground. For seals, this means that they have to exist in a “dusty” environment. In addition, no components of the seal that could negatively alter the pharmaceutical product in its composition or color must be allowed to migrate into the production process. The seal must also protect the pharmaceutical product against external influences in the sterile environment.

Product formulation by blood fractionation

In the separation of blood, the various blood constituents are separated by centrifugation. For fractionation, proteins are separated from blood plasma with the admixture of ethanol at $-3\text{ }^{\circ}\text{C}$ to $-6\text{ }^{\circ}\text{C}$ ($+27\text{ }^{\circ}\text{F}$ to $+21\text{ }^{\circ}\text{F}$). The plasma is cooled to $-30\text{ }^{\circ}\text{C}$ ($-22\text{ }^{\circ}\text{F}$) very quickly. Not every seal withstands this enormous jump in temperature. To avoid contamination, seals for this area must also be designed free of dead space and be resistant to CIP and SIP cleaning processes and cleaning media. Furthermore, defined emission limits must not be exceeded. Freudenberg offers special sealing materials for these aseptic high-purity processes in the pharmaceutical industry which are resistant to low temperatures and chemicals.

Biopharmaceuticals

Strict hygiene regulations prevail in the production of vaccines, enzymes or proteins which also apply to all other process components, such as seals. With respect to separation of the active ingredients, purity has top priority, which requires seals without dead space that provide no basis for germs. As in any hygienic area, cleaning is carried out with aggressive media using the CIP/SIP method in order to clean the plant free of residues. When mixing the ingredients, cooling is required which involves cold-resistant sealing materials. It is also important to protect the pharmaceutical product during filling in order to prevent process contamination.

THE PROCESS INDUSTRY AND ITS REQUIREMENTS

CHEMICAL INDUSTRY



The chemical industry is concerned with both the production of basic chemicals such as ammonia, acids, alkalis and simple hydrocarbons, and with the further processing of these materials into high-quality products. Thus, ammonia is obtained from nitrogen in order to produce a fertilizer from the former. For example, crude oil is used to produce simple hydrocarbons from which high-grade plastics are then synthesized.

Most of these media require excellent and comprehensive resistance characteristics of the seals used in order to ensure smooth operational processes, but also in equal measure robust features to withstand the sometimes extremely high pressures.

For this, Freudenberg offers highly-resistant sealing solutions made from synthetic materials such as PTFE, as well as a wide range of high-quality elastomeric materials such as perfluoroelastomers like Simriz[®], EPDM or FKM when elastomeric flexibility is required in less aggressive production environments.

A wide range of thermally and chemically-resistant flat gaskets is available especially for the pipes and flange connections that are frequently used in the chemical industry, as well as universally applicable secondary seals for the mechanical seals used in pumps.

The versatility of the processes in the manufacture and processing of chemicals requires separate examination of individual areas. A summary of the main applications is presented on the following page.



Processing inorganic basic chemicals

In the field of inorganic chemistry, numerous completely different applications occur. In addition to manufacturing, processing, separation, and many other process steps, particularly extreme parameters always prevail when handling inorganic basic chemicals. In addition to aggressive, to some extent also toxic media, high pressures are prevalent. The seals used here must have a broad operating temperature range. Corresponding to the multifaceted applications, high-quality, robust and chemically-resistant materials are required. To meet the high standards of the statutory emission values for these processes, the seal must make a significant contribution to this.

Handling petrochemicals and derivatives

A typical application in the petrochemical industry is so-called steam cracking. In addition to being resistant to aggressive chemicals, seals must withstand high temperatures and pressures. In a convection-capable furnace

for heating the bottom product, for example, there are temperatures of up to +600 °C (+1,112 °F) with simultaneous pressure and vaporization. During the subsequent cracking of the resulting gas, the temperatures increase further to +850 °C (+1,562 °F). The real challenge for seals is, however, in the intense temperature changes that occur during the subsequent cooling of the gas. The seal must also withstand the pressure increase during the compression of the cracked gas to about 30 bar. The absorption of gases requires the use of chemicals, in particular caustic solution.

Polymer production

During the handling of polymers (plastics), no particularly high demands in terms of pressure and temperature resistance prevail most of the time. Only in some cases, for example, during the termination of a reaction, temperatures as low as -80 °C (-112 °F) may occur, requiring the use of specially developed sealing solutions. In addition, the use of solvents can attack conventional sealing materials.

Fine and specialty chemicals

In the handling of fine and specialty chemicals, seals with an especially high thermal and chemical resistance are required. In addition to the use of harsh and sometimes toxic media, temperatures from +300 °C (+572 °F) down to the low-temperature range are not uncommon in crystallization processes. The material and the seal made from it must be able to cope with this.

Production of detergents and personal care products

The production of detergents and personal care products, whose requirements are similar to those of the pharmaceutical industry, makes especially high demands in terms of the purity and hygiene of all process media used. In addition to the lack of dead space of the sealing point, the sealing materials must have the prevalent approvals and clearances of the pharmaceutical industry and be able to withstand the sophisticated CIP/SIP cleaning media and processes.

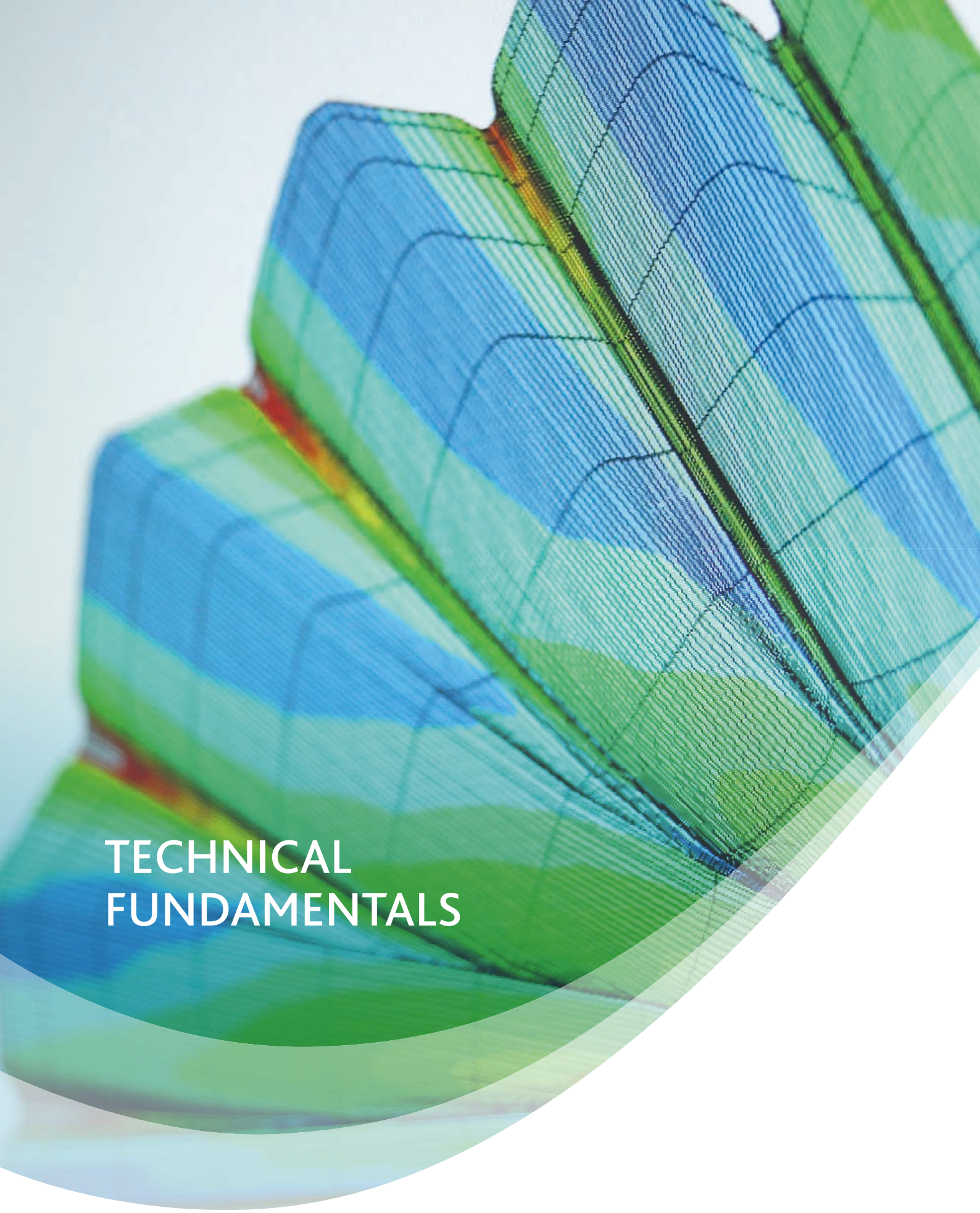

TECHNICAL FUNDAMENTALS

BASIC MATERIALS TESTING

Hardness, compression set (DVR) or the volume change of a material in use are important parameters which affect the sealing function but also the lifetime of the seal. Precise statements about the behavior of the material are therefore essential. Freudenberg uses a variety of testing procedures and methods for this.

Hardness tests

One of the most important parameters in rubber technology is the hardness. The nominal hardness is specified for all Freudenberg materials in the materials designation before the base elastomer (e.g. 70 EPDM 291) and determined using various standardized procedures. In the process, the parameter which is measured is always how far a given test specimen that penetrates into the material under a defined force.

Shore A pursuant to DIN 53 505 – The method according to DIN 53 505 was developed by Albert F. Shore in the 1920s and is the most commonly used method for measuring hardness in elastomers. The surfaces of the test specimen must be flat and coplanar. The value is read after a holding time of three seconds. The test according to Shore A is used mainly in materials development and in the clearance of mixture batches. It can only be used on molded parts if they have a sufficient thickness and flat supporting surfaces for the measurement. Shore A is suitable for hardnesses between 10 and 90. Above 90 Shore, Shore D measurements must be made, which, however, are not applied in case of elastomers.

IRHD pursuant to DIN ISO 48 – For hardness tests on seals, the IRHD (International Rubber Hardness Degree) pursuant to DIN ISO 48 is applied. Four procedures are described in this standard:

1. N (for hardnesses between 30 and 95 IRHD)
2. H (for hardnesses between 85 and 100 IRHD)
3. L (for the range from 10 to 35 IRHD)
4. M (micro hardness for the testing of small or thin-walled samples)

In sealing technology, the N and M processes are mainly used. The micro hardness measurements on seals are not directly comparable to the IRHD values, procedure N and the Shore A values on test plates.

Volume change measurement

Seals come into contact with a variety of media such as liquids and gases which influence the elastomer materials in different ways. A distinction is made between the chemical and physical effects of media. If an elastomeric compound is chemically affected, the properties are irreversibly changed. The splitting of the cross-linking points between the molecular chains leads to a softening and loss of elasticity of the material concerned. The formation of additional cross-linking points entails hardening leading to embrittlement of the material. Certain media can also attack the molecular chains of the elastomer and destroy them. Physical processes can be roughly divided into two groups:

- a. Absorption of the medium by the elastomer
- b. Extraction of soluble components of the mixture from the elastomer



Both changes can take place separately but also in parallel. These processes are detected by measuring the change in volume occurring thereby. If an increase in volume is measured, the absorption of medium takes precedence, while a decrease in volume means a predominant loss of mixture components. Swelling processes are usually reversible, which means that the absorbed medium can also leave the elastomer again when switching to another product.

The size of the volume change depends on five factors:

-
1. Type of medium
 2. Composition of the elastomeric compound
 3. Interaction parameters (temperature, time)
 4. Geometric form (thickness) of the seal
 5. Stress condition of the seal (in the case of stretched parts, the impact is greater, in the case of compressed parts lower)
-

Due to the cross-linked structure of the elastomers, swelling is limited, i.e. it no longer changes after reaching a limit value.

Every volume change, whether swelling or shrinkage, is associated with changes in the physical properties such as hardness, elasticity, tensile strength and elongation at break. Therefore, the determination of the volume change after a defined storage period (time and temperature) is a parameter in order to measure and evaluate the stability of elastomeric compounds in the media used. Note: In the food industry, not only must the production media (e.g. beer, mineral water, dairy products etc.) be tested for their compatibility with the sealing material, but so too must the cleaning and sterilization media used in the processes.

Sequence of the tests according to DIN ISO 1817:

-
1. The volume of the test specimen (the seal or a portion thereof) is determined
 2. The test specimen is stored in the medium according to the standard or to customer specifications
 3. At the end of the storage period (and after cooling down), the volume of the specimen is measured again
 4. The result is expressed as a percentage of the initial state
-

Compression set measurement/elasticity

The compression set refers to the ability of a material, after a certain time of contact with the medium in question, to generate a sufficient restoring force on the sealing surfaces and thus ensure the tightness. In a newly manufactured seal, the compression set is a measure for assessing the vulcanization and the degree of cross-linking. The lower the compression set value, the better the cross-linking and the longer the expected life of the mixture. It should be noted that the compression set is not an absolute value, but must always be considered in comparison with the initial or target values. The compression set is determined according to DIN ISO 815 using the following formula:

$$\text{DVR [\%]} = (h_0 - h_s) / (h_0 - h_1) \times 100 \%$$

With:

h_0 = height of the test specimen

h_1 = height of the compressed specimen

h_s = height of the relieved specimen

A number of conditions must be met during the measurement. Thus, the time between the vulcanization of the test specimen and the compression set test should be at least 16 hours. The compression is defined and generally amounts to 25%. The sample is stored in its apparatus in air (or a medium) for a predetermined period of time at a specified temperature and removed from the apparatus after expiry of the testing period. 30 minutes after removal, the thickness is measured again. Please note that compression set values are only comparable if the parameters are identical:

- Deformation (default: 25%)
- Duration of the deformation (default: 24 or 72 hours)
- Temperature during the deformation
- Storage medium (standard: air)
- Form of the test specimen

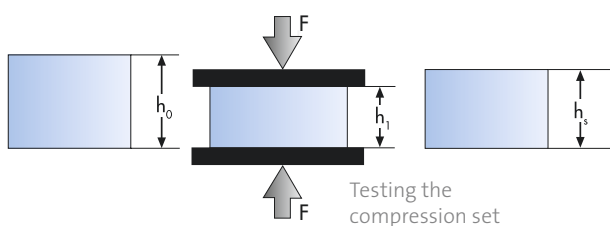

Density measurement

The density of vulcanized rubber is a specific characteristic. Through a simple, expeditious measurement of this parameter, first conclusions regarding the compound used can be drawn. In the preparation of a mixture, the density value serves as an indication whether all components of the mixture were added properly. Similarly, the density measurement precedes all other tests in the analysis of unknown mixtures in order to limit the number of possible materials. In general, the density is measured using the buoyancy-floatation method. According to the "Archimedean principle", a body experiences a buoyancy force when immersed in a liquid. This is calculated from the difference of the weight in air and the weight in liquid. Since the buoyancy force is equal to the weight of the fluid volume displaced by the body, the volume of the test specimen, regardless of its geometric shape, can be derived. The specific density can be calculated on the basis of the volume determined in this way and the weight in air.

$$\rho = [G_L / (G_L - G_F)] \times \rho_F$$

With:

ρ = density to be determined

G_L = weight in air

G_F = weight in fluid

ρ_F = density of the fluid (in case of water approx. 1 g/cm³)

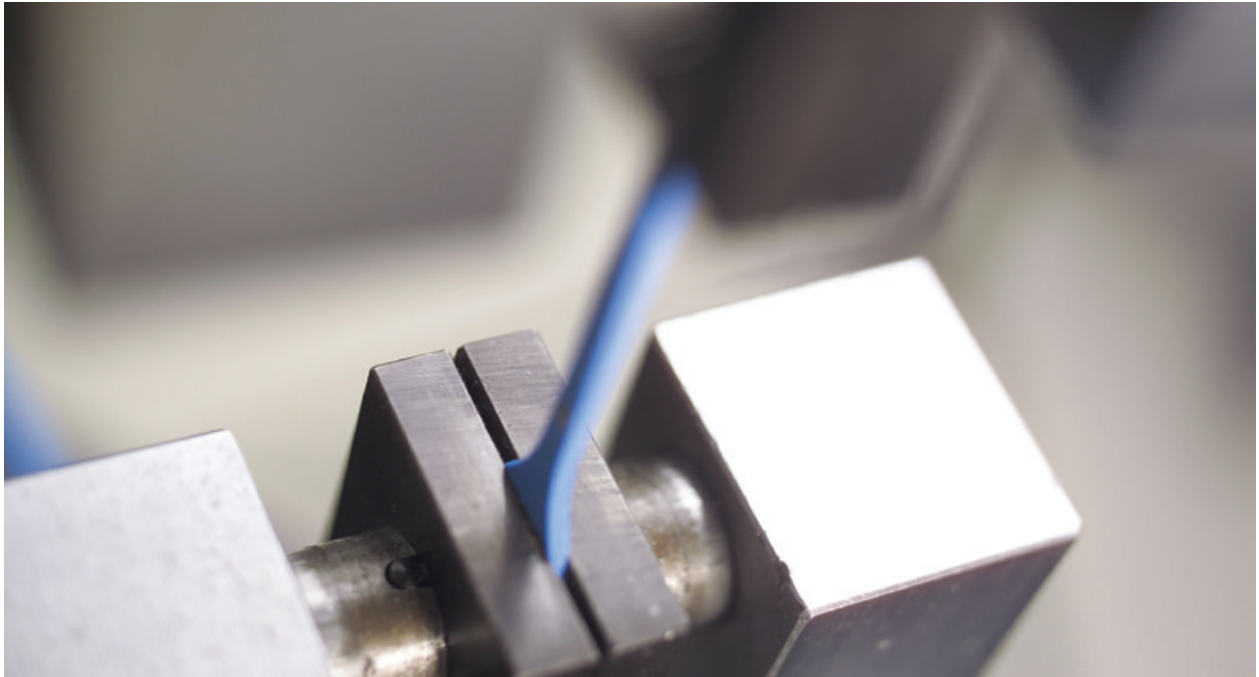

Tensile test

Tensile tests are used to determine the tear strength, tensile strength, elongation at break, and the stress values of elastomeric materials. The test specimens used for this purpose are usually tensile bars or standardized rings with rectangular cross-sections. These are stretched at a constant speed to break. In the tensile test according to DIN 53504, as many points as possible of the force-length change curve (tensile force with corresponding change in length of the sample) are recorded.

The following values can be calculated from the experiment:

1. The tear strength is the quotient of the force achieved at the moment of rupture and the initial cross-section of the specimen
2. The tensile strength is the quotient of the measured maximum force and the initial cross-section of the specimen. Tear strength and tensile strength are generally the same in elastomers, if the measurement is performed at room temperature or above
3. The elongation at break is the ratio of the length change achieved at the moment of rupture to the initial length
4. The stress value is defined as the quotient of the tensile force existing when a certain elongation is achieved and the initial cross-section

The three characteristics tear strength, 100% stress value and elongation at break are indicated on the material data sheets of the Freudenberg elastomers. They describe the behavior of the respective material to tensile stress.

Resistance to tear propagation

The tear propagation resistance is a measure of the sensitivity of elastomers in the event of cutting and tearing damage. The most common test to determine tear propagation resistance is the strip test according to DIN ISO 34-1 (DIN 53 507). In this case, a longitudinal cut is made in the material to be tested, the two half-strips are clamped in a pulling machine and pulled apart. The force subtended by the test specimen to the tear propagation is measured in relation to the sample thickness.

A further testing method is the angle test specimen according to DIN ISO 34-1 (DIN 53 515). Here, an incision is made in an angled ("bent") sample manufactured in a form, and the sample is similarly pulled apart using a pulling machine. The measured values do not need to correlate with the stress values determined in the tensile test. Since the results of the tear propagation resistance test strongly depend on the specific test conditions and particularly on the shape of the sample, it is crucial that the test method and the sample shape are always indicated when the results are stated.

STORAGE CONDITIONS



Articles made of rubber are subject to aging. Modern elastomer materials are more stable and have longer service lives than their predecessors from earlier generations, both regarding the base rubber and also as a result of suitable mixing additives.

The aging process depends largely on the following factors:

- Temperature
- Thermal radiation
- Solar radiation
- Humidity
- Relative air humidity
- Ozone and ionizing radiation
- Stress condition of the component

Rules for the storage of elastomer products can be derived from this:

1. The storage temperature must be below +25 °C (+77 °F)
2. There must be no direct heat sources in the storage area
3. The seals must not be exposed to direct sunlight
4. Exposure to ozone and ionizing radiation must strictly be excluded
5. The seals must be stored without stress, as far as possible
6. The relative air humidity has to prevent condensation in case of temperature changes in the store room

To meet these requirements, all container, cover and packaging materials must be free of substances that have a degradation effect on elastomers. Therefore, primarily PE-coated kraft paper, aluminum foil or opaque polyethylene film (minimum thickness 0.075 mm) are used.

GROUP	MATERIALS	STORAGE PERIOD IN YEARS	EXTENSION PERIOD IN YEARS
1	NR, AU, EU, SBR	5	2
2	NBR, HNBR, XNBR, ACM, AEM, ECO, CIIR, CR, IIR	7	3
3	FKM, FFKM, VMQ, PVMQ, FVMQ, EPDM, Fluoroprene® XP, CSM	10	5

The storage and the recording of the time in storage of vulcanized rubber products are described in ISO 2230. In this standard, the elastomer products are divided into three groups to which different storage times are assigned.

APPROVALS, EXAMINATIONS, COMPLIANCES

	APPROVALS/CONFORMITIES	ORGANIZATION	LEGAL BASIS
DRINKING WATER INDUSTRY	W 270	DVGW – Deutscher Verein des Gas- und Wasserfaches (German Association of Gas and Water)	Recommendation
	KTW – materials in drinking water	BfR – Bundesinstitut für Risikobewertung (Institute for Risk Assessment)	German Food and Feed Code LFGB (§ 2 para. 6 sentence 1 no. 1)
	ACS	ACS – Attestation de Conformité Sanitaire (French association for sanitary affairs)	AFNOR XO P41-250 part 1 – 3 (Association française de normalisation)
	WRAS	WRAS – Water Regulations Advisory Scheme	BSI 6920 and BS 2494
	ÖNORM	ÖVGW – Österreichische Vereinigung für das Gas- und Wasserfach (Austrian Association of Gas and Water)	ÖNORM B5014/part 1
	KIWA	Ministerial Expert Committee + Toxicity Subcommittee	Direktive Doc. 94-01
	ETA-DK (Danish Board of European Technical Approvals)	DEPA and DTC	NKB rules + DS/EN standards
	NSF 61	National Sanitation Foundation	NSF Standard 61
	AS/NZS 4020:2005	AWQC – Australian Water Quality Centre	AS/NZS 4020:2005
FOOD AND BEVERAGE INDUSTRY	EU (VO) 1935/2004	European Parliament	EU Reg. 1935/2004
	EU (VO) 10/2011	European Parliament	EU Reg. 10/2011
	BfR 21. recommendation for rubbers	BfR – Bundesinstitut für Risikobewertung (Institute for Risk Assessment)	LFGB (German Food and Feed Code)
	BfR 15. recommendation for silicone materials	BfR – Bundesinstitut für Risikobewertung (Institute for Risk Assessment)	LFGB (German Food and Feed Code)
	FDA	Food and Drug Administration	<ul style="list-style-type: none"> FDA 21 CFR 177.2600 (Elastomers & Perfluoroelastomers) FDA 21 CFR 177.1500 (Plastics)
	NSF 51	National Sanitation Foundation	<ul style="list-style-type: none"> FDA 21 CFR 177.2600 (Elastomers & Perfluoroelastomers) FDA 21 CFR 177.1500 (Plastics)
	3-A ^o Sanitary Standards	3-A ^o	FDA 21 CFR 177.2600
	ADI free		EMEA/410/01 rev2
PHARMA-CEUTICAL INDUSTRY	USP Chapter 87	United States Pharmacopeia	USP 29
	USP Chapter 88 – USP Class VI – 121 °C (250 °F)	United States Pharmacopeia	USP 29

AREA OF APPLICATION	TESTING INSTITUTE	TESTING ON	VALIDITY PERIOD	TESTING CRITERIA
Germany	DVGW-certified laboratories	Material	5 years	Microbiological examination
Germany	DVGW-certified laboratories	Material and product	5 years	<ul style="list-style-type: none"> • BfR positive list • Chlorine loss • TOC (total organic carbon) level • Migration tests
France	CRECEP – Paris LHRSP – Nancy IP – Lille	Material and product	5 years	<ul style="list-style-type: none"> • Positive list • Material composition • Cytotoxicity • TOC level
Great Britain	WRAS-certified laboratories	Material and product	5 years	<ul style="list-style-type: none"> • Material composition • Manufacture • Cytotoxicity • Migration tests
Austria (also accepts the KTW test)	ÖVGW-certified laboratories	Material and product	5 years	<ul style="list-style-type: none"> • Positive list • Material composition • Chlorine loss • TOC level • Migration tests
Netherlands	KIWA	Material and product	5 years	<ul style="list-style-type: none"> • Material composition • Manufacture • Toxicity tests • Migration tests • Microbiological examination
Denmark (also accepts the KTW test)	Certified laboratories	Material and product	5 years	<ul style="list-style-type: none"> • Positive list • Material composition • Manufacture • TOC level • Migration tests
USA	NSF-certified laboratories	Material and product	5 years with annual audit	<ul style="list-style-type: none"> • Material composition • Examination of the components • Toxicity tests • Microbiological examination
Australia	AWQC-certified laboratories	Material and product	5 years	<ul style="list-style-type: none"> • Material composition • Manufacture • Toxicity tests • Migration tests
Europe	Every accredited testing laboratory	Material	unlimited	<ul style="list-style-type: none"> • BfR 21. recommendation cat. 4 • ADI free
Europe	Every accredited testing laboratory	Material	unlimited	<ul style="list-style-type: none"> • Determination of OML and SML values in different media and temperatures
Germany	Every accredited testing laboratory	Material	unlimited	<ul style="list-style-type: none"> • BfR positive list • Migration tests (subdivided into categories, depending on the contact time)
Germany	Every accredited testing laboratory	Material	unlimited	<ul style="list-style-type: none"> • BfR positive list • Migration tests (subdivided into categories, depending on the contact time)
USA (also accepted in Europe)	Every accredited testing laboratory	Material	unlimited	<ul style="list-style-type: none"> • FDA positive list • Migration tests
USA	NSF-certified laboratories	Material and/or product	5 years with annual audit	<ul style="list-style-type: none"> • FDA positive list • Migration tests
USA (also accepted in Europe)	Every accredited testing laboratory	Material	unlimited	<ul style="list-style-type: none"> • FDA positive list • Resistance tests in defined media and classification according to specified limits
Worldwide	Each individual material supplier	Material	unlimited	Testing of the formulation for animal-derived ingredients
USA (also accepted in Europe)	Licensed laboratories	Material	unlimited	Testing of the compatibility on living organisms (in vitro)
USA (also accepted in Europe)	Licensed laboratories	Material	unlimited	Testing of the compatibility on living organisms (in vivo)

HYGIENIC DESIGN

The selection of materials according to the operating conditions, taking into account the required purity with the corresponding conformities, is only the first step towards fulfilling the hygiene requirements.

The most important duty of every plant operator is to know and to obey all legal requirements and procedures to ensure a proper product quality. Every food, pharmaceutical and cosmetic product must be clean and not endanger the health of the consumer in any way.

A plant constructed according to hygienic design is characterized by good cleanability so that contamination by microorganisms cannot occur. The more the use of the automated CIP and SIP (Cleaning In Place/Sterilization In Place) processes spreads, the less equipment needs to be disassembled. This eliminates the possibility of visual control. It must therefore be possible to trust automated cleaning to achieve a good result and it must be certain that there are no dead spaces in which product residues can collect initially and microorganisms can settle later. This means that rectangular grooves with a degree of filling of about 80% are not permitted. Hygienically designed grooves are narrower and the evasion spaces for sealing materials are correspondingly limited.

Elastomers and steel behave differently with respect to production and temperature. Elastomers have significantly greater manufacturing tolerances so that in the event of an incorrect design an overfilling of the groove may in extreme cases already exist during installation. Elastomers are incompressible and need an allowance for expansion. The thermal expansion of elastomers exceeds that of steel by a factor of 15 and must be taken into account. As a result of overly narrow gaps, extreme stresses can arise during cooling, resulting in shearing of the material.

Attention must also be paid to the absence of any dead space in the event of dynamic seals, such as rotary shaft seals. While rotary shaft seals are very difficult to clean, the HTS II 9539 with no dead space and with its protruding lip seal made of PTFE is barely subject to contamination and very easy to clean.

STANDARDIZED CONNECTIONS



HTS II 9539 VL
Version with no dead space and protruding sealing lip for applications according to hygienic design

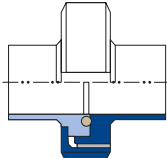

DIN 11864
Aseptic O-ring screw connection

- Metallic stop
- Leak-free
- Aseptic and hygienic connections

European Hygienic Engineering and Design Group

The EHEDG is an interest group for operators and suppliers of equipment for the production of food, pharmaceuticals and cosmetics as well as for test institutes and maintenance companies. Freudenberg is a member of the EHEDG and is very involved in advancing the interests of hygienic design, including through active participation in the development of recommended practice.

Heat exposure of O-rings

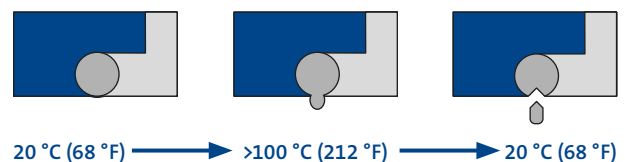

FRICITION OPTIMIZATION

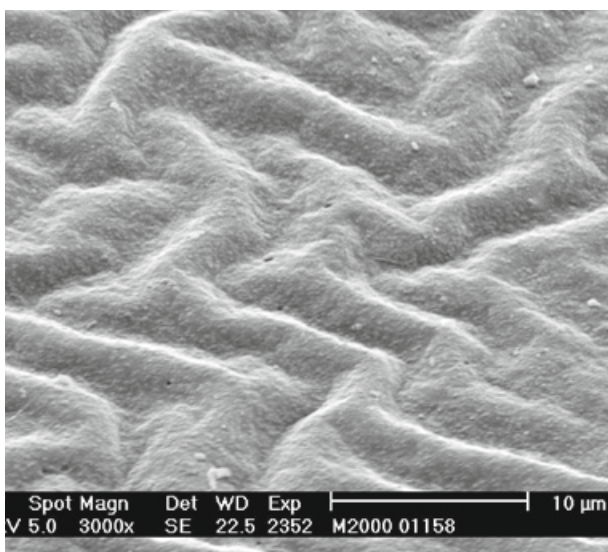

The friction of elastic materials on hard surfaces differs significantly from friction processes between two metals.

The known states describe the conditions during the friction of sealing materials only insufficiently:

- Fluid friction (the two gliding partners are completely separated from each other by a lubricant film)
- Mixed friction (the gliding partners touch each other only on the roughness peaks)
- Dry friction (no lubricant available)

Due to the elasticity of the sealing material, the elastomer adapts to the roughness of the mating surface, which increases the friction force significantly. The softer the elastomer and the higher the force with which it is pressed against the mating surface, the more this effect is evident. The conditions are therefore significantly different from those of classical friction between two solid bodies.

Reasons for a necessary friction reduction in elastomer products:

- Reduction of the adhesion of seals to each other or to the container walls. This is particularly necessary in case of automatic assembly. O-rings, for example, should not “stick” to each other, but glide easily
- Reduction of friction during installation of seals. For example, if O-rings must be pushed over shafts or shoulders, they can easily become twisted in case of excessive friction and therefore also lie twisted in the groove. This increases the risk of leakage
- Reduction of friction in dynamic applications with the aim to increase the service life of the seal

Dusting with talc (magnesium silicate hydrate)

Treatment with talc prevents the seals sticking to each other and to container walls. It simplifies installation, but is not suitable as a durable friction reduction for dynamic applications. Automatic assembly equipment can be contaminated by talc.

Immersion in emulsions

The same effect as in talc coating occurs by wetting the surface with emulsions. The coat application here does not rest loosely and in powder form (and thus dusty) on the surface, but is liquid and adheres to the surface. Therefore, the contamination tendency is lower than for talc dusting.

Lubrication with grease or oil

If requested, seals can be delivered lightly greased or oiled. It is important to note that the assembly equipment may be soiled by the greases or oils. In addition, the compatibility of the greases and oils must be matched with the sealing materials. In a dynamic application, the seals should be lubricated only shortly before assembly, because this will achieve good long-term lubrication.

RFN treatment (Reduced Friction by Nanotechnology)

In this procedure developed by Freudenberg New Technologies, the surface properties can be set in such a way that the adhesion and thus the jamming of the components is significantly and permanently reduced. Furthermore, the surface can be designed extremely hard and thus with low-wear and low-friction properties so that RFN-treated products are predestined for dynamic applications. Due to the special process, the materials retain their elastic behavior and dimensional stability. RFN treatment has approval for drinking water applications and is resistant to common CIP/SIP cleaning agents.

Coating with PTFE varnishes

PTFE coatings adhering firmly to the surface of elastomers provide a high degree of friction reduction. However, the relatively soft PTFE layer is lightly abraded in dynamic continuous operation. Despite abrasion of the coating, a certain amount of friction reduction is maintained since the PTFE burrows into the valleys of the roughness profile of the mating surface and fills them. The slide-active PTFE layer is not as elastic as the base material, however. Thus, the PTFE layer forms cracks in the event of greater elongation which may lead to leaks or cause the layer to flake off.

Halogenation

In this method, the surface is hardened in the micro range and thus does not get pressed as strongly into the roughness profile of the mating surface. The result is a better gliding property. However, the layer is abraded in the event of high dynamic stress, so that the seals lose their gliding property. The method is very well-suited for the automated assembly of O-rings since the rings are dry and powder-free. The devices remain clean and free of abrasion over a very long period of time.

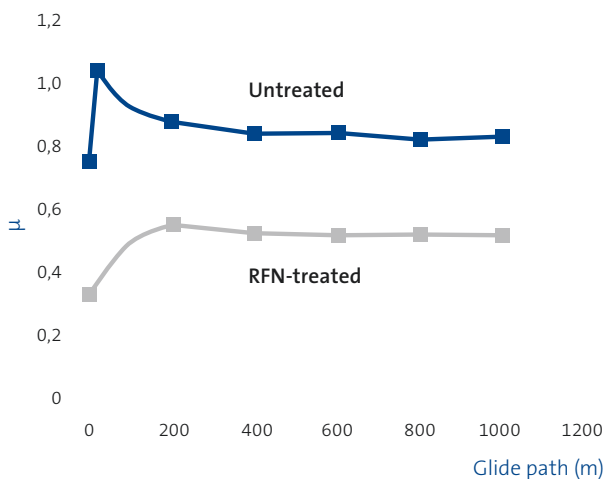



ELASTOMERIC MATERIALS

OVERVIEW OF ELASTOMERIC MATERIALS

MATERIAL TYPE	NAME	COLOR	CROSSLINKING	HARDNESS SHORE A	TEMPERATURE RANGE IN AIR
EPDM	60 EPDM 290	black	peroxidic	65 ± 5	-40 to +150 °C (-40 to +302 °F)
	70 EPDM 291	black	peroxidic	75 ± 5	-40 to +150 °C (-40 to +302 °F)
	70 EPDM 391	black	peroxidic	70 ± 5	-40 to +150 °C (-40 to +302 °F)
	85 EPDM 292	black	peroxidic	85 ± 5	-40 to +150 °C (-40 to +302 °F)
	85 EPDM 302	black	peroxidic	85 ± 5	-40 to +150 °C (-40 to +302 °F)
	75 EPDM 253356	black	peroxidic	75 ± 5	-30 to +140 °C (-22 to +284 °F)
	70 EPDM 253815	white	peroxidic	70 ± 5	-40 to +150 °C (-40 to +302 °F)
VMQ	78 VMQ 166898	grey	peroxidic	78 ± 5	-40 to +200 °C (-40 to +392 °F)
	76 VMQ 176643	red	peroxidic	76 ± 5	-40 to +200 °C (-40 to +392 °F)
	70 VMQ 117055	transparent	peroxidic	70 ± 5	-50 to +200 °C (-58 to 392 °F)
NBR	70 NBR 150	black	peroxidic	70 ± 5	-20 to +100 °C (-4 to +212 °F)
	88 NBR 156	black	peroxidic	88 ± 5	-25 to +100 °C (-13 to +212 °F)
HNBR	70 HNBR 254067	green	peroxidic	70 ± 5	-30 to +140 °C (-22 to +284 °F)
	75 HNBR 231142	black	peroxidic	78 ± 5	-35 to +140 °C (-31 to +284 °F)
	85 HNBR 216553	green	peroxidic	85 ± 5	-25 to +140 °C (-13 to +284 °F)
FLUOROPRENE® XP	75 Fluoroprene® XP 40	blue	peroxidic	75 ± 5	-15 to +200 °C (+5 to +392 °F)
	75 Fluoroprene® XP 41	blue	peroxidic	75 ± 5	-15 to +200 °C (+5 to +392 °F)
	85 Fluoroprene® XP 43	blue	peroxidic	85 ± 5	-15 to +200 °C (+5 to +392 °F)
	75 Fluoroprene® XP 44	blue	peroxidic	75 ± 5	-15 to +200 °C (+5 to +392 °F)
FKM	75 FKM 180497	black	bisphenolic	75 ± 5	-25 to +200 °C (-13 to +392 °F)
	70 FKM 37508	red-brown	bisphenolic	75 ± 5	-15 to +200 °C (+5 to +392 °F)
	75 FKM 38269	black	peroxidic	75 ± 5	-25 to +200 °C (-13 to +392 °F)
SIMRIZ®	70 Simriz® 491	black	peroxidic	70 ± 5	-20 to +230 °C (-4 to +446 °F)
	75 Simriz® 494	black	peroxidic	75 ± 5	-15 to +230 °C (+5 to +446 °F)
	75 Simriz® 495	black	peroxidic	75 ± 5	-15 to +250 °C (+5 to +482 °F)
	75 Simriz® 497	black	peroxidic	75 ± 5	-15 to +325 °C (+5 to +617 °F)
	75 Simriz® 506	white	peroxidic	72 ± 5	-15 to +230 °C (+5 to +446 °F)
	80 Simriz® 492	black	peroxidic	80 ± 5	-10 to +230 °C (+14 to +446 °F)
	85 Simriz® 496	black	peroxidic	85 ± 5	-15 to +250 °C (+5 to +482 °F)

PRODUCTS	FOOD/PHARMACEUTICAL	DRINKING WATER	OTHERS
• Diaphragms	• FDA 21 CFR 177.2600 • EU Reg. 1935/2004 and 2023/2006	• W 270	• ADI free
• Clamp seals • Diaphragms • Hygienic Usit®	• Molded parts • O-rings • CNC machined	• FDA 21 CFR 177.2600 • 3-A° Sanitary Standards Class II • EU Reg. 1935/2004 and 2023/2006 • USP Ch. 87 and Ch. 88 – Class VI – 121 °C (250 °F) • NSF 51	• NSF 61 • KTW • W 270 • ACS • KIWA • ÖNORM B 5014-1 • ADI free
• Profiles • Cords	• FDA 21 CFR 177.2600 • EU Reg. 1935/2004 and 2023/2006 • USP Ch. 87		• ADI free
• Molded parts • O-rings • CNC machined	• FDA 21 CFR 177.2600 • 3-A° Sanitary Standards Class II • EU Reg. 1935/2004 and 2023/2006 • USP Ch. 87 and Ch. 88 – Class VI – 121 °C (250 °F)	• NSF 61 • KTW • W 270 • WRAS	• ADI free
• Molded parts	• FDA 21 CFR 177.2600 • EU Reg. 1935/2004 and 2023/2006 • USP Ch. 87 and Ch. 88 – Class VI – 121 °C (250 °F)		• ADI free
• Molded parts • CNC machined	• FDA 21 CFR 177.2600 • EU Reg. 1935/2004 and 2023/2006		• ADI free
• Clamp seals • Molded parts • O-rings • Hygienic Usit®	• FDA 21 CFR 177.2600 • 3-A° Sanitary Standards Class II • EU Reg. 1935/2004 and 2023/2006 • USP Ch. 87 and Ch. 88 – Class VI – 121 °C (250 °F)		• ADI free
• O-rings	• FDA 21 CFR 177.2600 • EU Reg. 1935/2004 and 2023/2006		• ADI free
• Molded parts	• FDA 21 CFR 177.2600 • EU Reg. 1935/2004 and 2023/2006		• ADI free
• Clamp seals • Molded parts • Diaphragms • O-rings	• FDA 21 CFR 177.2600 • 3-A° Sanitary Standards Class I • EU Reg. 1935/2004 and 2023/2006 • USP Ch. 87 and Ch. 88 – Class VI – 121 °C (250 °F)		• ADI free
• Clamp seals • Molded parts • Diaphragms	• CNC machined • O-rings	• FDA 21 CFR 177.2600 • EU Reg. 1935/2004 and 2023/2006	• NSF 61 • ACS • ADI free
• Molded parts • O-rings	• CNC machined	• FDA 21 CFR 177.2600 • EU Reg. 1935/2004 and 2023/2006	• ADI free
• Molded parts		• FDA 21 CFR 177.2600	• ADI free
• O-rings		• FDA 21 CFR 177.2600	• ADI free
• Molded parts		• FDA 21 CFR 177.2600	• ADI free
• O-rings		• FDA 21 CFR 177.2600 • 3-A° Sanitary Standards Class I • EU Reg. 1935/2004 and 2023/2006 • USP Ch. 88 – Class VI – 121 °C (250 °F)	• ADI free
• Clamp seals • Molded parts • CNC machined • Hygienic Usit®	• O-rings • Diaphragms • Profiles	• FDA 21 CFR 177.2600 • 3-A° Sanitary Standards Class I • EU Reg. 1935/2004 and 2023/2006 • USP Ch. 87 and Ch. 88 – Class VI – 121 °C (250 °F) • NSF 51	• ADI free
• Molded parts		• FDA 21 CFR 177.2600 • 3-A° Sanitary Standards Class I • EU Reg. 1935/2004 and 2023/2006 • USP Ch. 87 and Ch. 88 – Class VI – 121 °C (250 °F)	• ADI free
• Diaphragms		• FDA 21 CFR 177.2600 • EU Reg. 1935/2004 and 2023/2006	• ADI free
• Molded parts • Diaphragms • O-rings		• FDA 21 CFR 177.2600 • 3-A° Sanitary Standards Class I • EU Reg. 1935/2004 and 2023/2006	• ADI free
• Molded parts • Diaphragms • O-rings		• FDA 21 CFR 177.2600 • 3-A° Sanitary Standards Class I • EU Reg. 1935/2004 and 2023/2006 • USP Ch. 87 and Ch. 88 – Class VI – 121 °C (250 °F)	• ADI free
• O-rings		• FDA 21 CFR 177.2600 • EU Reg. 1935/2004 and 2023/2006 • 3-A° Sanitary Standards Class I	• ADI free
• Molded parts • Diaphragms • O-rings			• ADI free • Low temperature
• Diaphragms on request • O-rings		• FDA 21 CFR 177.2600 • EU Reg. 1935/2004 and 2023/2006 • USP Ch. 87 and Ch. 88 – Class VI – 121 °C (250 °F)	• ADI free
• O-rings			• ADI free
• Molded parts • O-rings			• High temperature
• Molded parts • O-rings		• FDA 21 CFR 177.2600 • EU Reg. 1935/2004 and 2023/2006 • USP Ch. 87 and Ch. 88 – Class VI – 121 °C (250 °F)	• ADI free
• Molded parts • O-rings			• Chemical application • Chemical application

EPDM

The excellent resistance to water and aqueous systems makes EPDM (ethylene-propylene-diene rubber) the most widely used material in food production and processing, with a share of about 70%.

General properties

- Very good resistance to aging, ozone and light
- High heat and cold resistance, approx. $-50\text{ }^{\circ}\text{C}$ to $+150\text{ }^{\circ}\text{C}$ ($-58\text{ }^{\circ}\text{F}$ to $+302\text{ }^{\circ}\text{F}$)
- Good tensile elongation and strength
- Very high abrasion resistance
- Very good resistance to water and to polar and oxidative media
- Excellent elastic behavior

70 EPDM 291 (black) and 70 EPDM 253815 (white)

Application profile

EPDM seals exhibit good chemical resistance in hot water, steam, acids and alkaline solutions. They are very well suited for use in all polar media and therefore also in CIP/SIP media. CIP media are diluted acids or alkaline solutions with cleaning additives. In SIP media, disinfectants, steam or oxidizing media (e.g. peracetic acid) or polar organic solvents (e.g. acetic acid) are used. EPDM is of limited use in products containing fats or oils. While it can be used well at low temperatures in dairy products with a fat content of up to 70%, it cannot be used in pure fats, oils or non-polar solvents.

EPDM contains no plasticizers and other potential extractable ingredients and therefore displays negligible amounts of extract in the extractables study (see page 61 f.). Thus, the materials EPDM 291 and EPDM 253815 can be recommended for use in the manufacture of medical products.

RULES AND STANDARDS	70 EPDM 291	70 EPDM 253815
FDA-compliant (CFR 21 Part 177.2600)	+	+
EU Reg. 1935/2004 EU Reg. 2023/2006	+	+
3-A* Sanitary Standards Class II*	+	+
USP Ch. 87 (in vitro) USP Ch. 88 (in vivo), Class VI – 121 °C (250 °F)	+	+
Drinking water: DVGW (W 270 and 534), KTW, WRc-NSF, NSF 61, ÖVGW, ACS, WQC	+	
NSF 51	+	

*Note:

- Class II because of the bad resistance against fat and oil (max. 8 % butterfat at $+70\text{ }^{\circ}\text{C}$ ($+158\text{ }^{\circ}\text{F}$))
- Class I in aqueous CIP/SIP media at $+82\text{ }^{\circ}\text{C}$ ($+180\text{ }^{\circ}\text{F}$)
- Class I in sterilization at $+149\text{ }^{\circ}\text{C}$ ($+300\text{ }^{\circ}\text{F}$)

Suitable areas of application

- Hot water and steam (on a sustained basis up to $+180\text{ }^{\circ}\text{C}$ ($+356\text{ }^{\circ}\text{F}$), briefly up to $+210\text{ }^{\circ}\text{C}$ ($+410\text{ }^{\circ}\text{F}$))
- Acids (hydrochloric acid, nitric acid and phosphoric acid)
- Alkaline solutions (sodium hydroxide solution, potassium hydroxide solution)
- Polar organic solvents
- CIP/SIP media for continuous operation plants in the food, beverage and pharmaceutical industries

EPDM in the dairy industry

EPDM cannot be used in every product containing fat, which limits but does not completely rule out its use in the dairy industry. According to DIN 11483, dealing with dairy plants, the use of EPDM is only recommended for products with a fat content of up to 15%. This is no longer true today as such. The chart gives a rough indication of the usability of EPDM in the interaction between fat content and temperature of the medium. If the process parameters are below the curve, EPDM can and should be used. Only in applications with parameters above the curve should a different elastomer be selected. EPDM is also of only limited use



according to the 3-A® Sanitary Standards, which have classified EPDM as a Class II material. Nevertheless, EPDM is certainly suitable for contact with perishable foods at low temperatures and less fatty media. In particular, its excellent cleaning and sterilization properties, which no other elastomer in this price range offers, speak for EPDM.

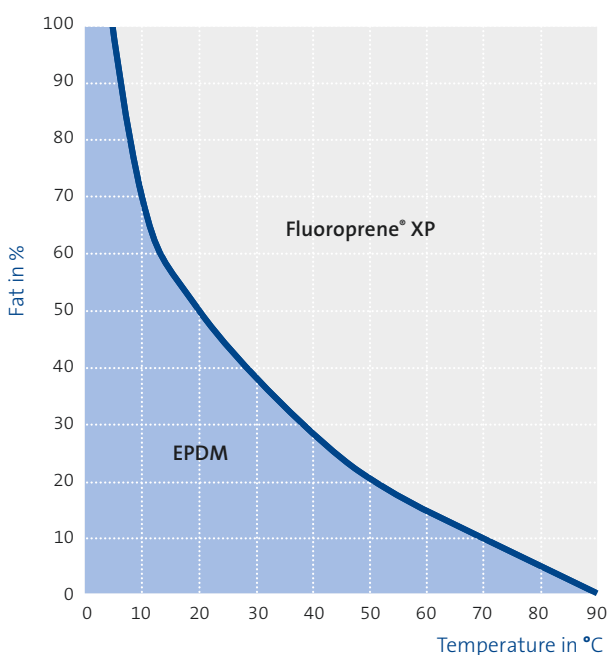

EPDM in the beverage industry

EPDM is recommended for applications in the beverage industry, since it shows very good performance in the aqueous media of breweries, mineral water and soft drinks manufacturers. Whether beer, mineral water or flavored drinks – butterfly valve seals made of EPDM, for example, are best suited for the application. There are limitations in the contact with citrus juices and drinks with orange flavors. Because of the same chemical nature of EPDM and limes, a terpene (the lead compound in orange flavor), it quickly leads to swelling of the material in continuous use. Another limitation is the flavor transfer between the produced drinks batches. This occurs especially in highly aggressive and complex assembled aromatic blends, like in energy drinks.

EPDM in the pharmaceutical industry

In addition to the cleaning media, EPDM materials are also suitable for aqueous pharmaceutical products. Thus, for example, EPDM materials are preferably used in the sterilizable biochemical reactor for the fermentation. Furthermore, EPDM is also used in autoclaves for steam pressure sterilization of culture media for biotechnological production methods. For the synthesis of many active ingredients, polar solvents such as ethanol or isopropanol are used. EPDM is the most suitable material for this. The exceptions are non-polar solvents and aliphatic products, such as water-in-oil emulsions (W/O emulsions). In this case, a fluorinated elastomer should be used.

EPDM in the chemical industry

In the chemical industry, EPDM is recommended where polar solvents, aqueous salt solutions, diluted acids and alkaline solutions are used.

Products and materials

- O-rings made of 70 EPDM 291, 85 EPDM 292 and 70 EPDM 253815
- Molded parts made of 70 EPDM 291, 85 EPDM 292, 70 EPDM 253815 and 85 EPDM 302
- Butterfly valve seals made of 75 EPDM 253356 and 70 EPDM 253815
- Clamp seals made of 70 EPDM 291 and 70 EPDM 253815
- Diaphragms made of 70 EPDM 291 and 60 EPDM 290
- Elastomer bead of the Hygienic Usit® made of 70 EPDM 291, 70 EPDM 217676 and 70 EPDM 253815
- Profiles and cords made of 70 EPDM 391

Download

Data sheet 70 EPDM 291



Download

Data sheet 70 EPDM 253815



VMQ

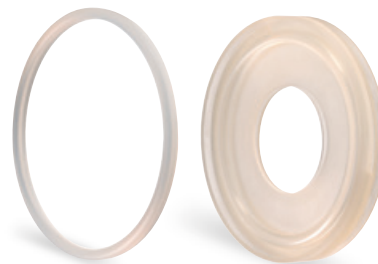

VMQ silicone rubbers are highly polymeric vinyl-methyl-polysiloxanes. Silicone is quite widespread as a material in butterfly valve seals. Due to its low volumetric expansion under the influence of media and its high elasticity, the butterfly valve switches reliably until the end of its service life.

Another argument for VMQ in contact with food and pharmaceuticals is its purity, clearly visible in the transparency of the material, even if the mechanical strength and chemical resistance are not optimal, especially during intense cleaning operations.

General properties

- Excellent thermal and heat resistance
- Best low-temperature flexibility
- Little temperature dependency of the technological properties
- Excellent weathering, aging and ozone resistance
- High gas permeability
- Very good physiological properties
- Very good dielectric properties
- Good resistance to synthetic, animal and vegetable oils, glycols, fire-resistant hydraulic fluids and various solvents
- Not resistant in low-molecular esters and ethers, aliphatic and aromatic hydrocarbons
- Temperature-resistant from -60 °C to +200 °C (-76 °F to +392 °F)

70 VMQ 117055, 76 VMQ 176643 and 78 VMQ 166898

Application profile

VMQ as a silicone rubber has very good applicability in animal and vegetable fats, oils and waxes and essential oils. Moreover, the material also allows application in high temperature ranges. VMQ also has good properties in the application of CIP/SIP media for continuous operation plants in the food and pharmaceutical industries, with the exception of steam sterilization. VMQ should not be used in concentrated acids (e.g. nitric acid, formic acid), concentrated oxidizing media (e.g. peracetic acid) or in water and steam above +100 °C (+212 °F), esters and ethers and aromatic hydrocarbons. Furthermore, it should be noted that VMQ does not swell, but loses hardness and tensile strength under the influence of the wrong media.

Products and materials

- O-rings made of 70 VMQ 117055 and 78 VMQ 166898
- Molded parts made of 70 VMQ 117055 and 76 VMQ 176643
- Diaphragms made of 70 VMQ 117055
- Clamp seals made of 70 VMQ 117055

RULES AND STANDARDS	70 VMQ 117055	76 VMQ 176643	78 VMQ 166898
FDA-compliant (CFR 21 Part 177.2600)	+	+	+
EU Reg. 1935/2004 EU Reg. 2023/2006	+	+	+
3-A° Sanitary Standards Class I	+		
USP Ch. 87 (in vitro) USP Ch. 88 (in vivo), Class VI – 121 °C (250 °F)	+		

Download
Data sheet 70 VMQ 117055



Download
Data sheet 76 VMQ 176643



Download
Data sheet 78 VMQ 166898



NBR



NBR (acrylonitrile-butadiene-rubber) is a polymer of butadiene and acrylonitrile (ACN). The proportion of acrylonitrile can be between 18% and 50% and significantly affects the properties of the polymer. Thus, an NBR with a low acrylonitrile content is characterized by a very good low-temperature flexibility and good elastic properties. The higher the ACN content, the better the resistance against polar media.

The gas permeability and flexibility at low temperature decrease in this context. NBR is only used sporadically in the food industry. The remaining applications are usually characterized by high mechanical forces, where a large energy input into the seal takes place. NBR resists this quite well, if no high demands in terms of temperature are placed on it and if a particularly cost-effective solution is sought.

General properties

- Very good abrasion resistance
- The acrylonitrile content must be selected for each application in such a way that the material shows the optimal combination of chemical resistance and low-temperature flexibility
- Good mineral oil and fuel resistance and outstanding resistance to vegetable and animal oils, silicones, as well as to diluted acids and alkaline solutions at room temperature
- NBR tends to swell in aromatic and chlorinated hydrocarbons, as well as in polar solvents
- Temperature-resistant from $-30\text{ }^{\circ}\text{C}$ to $+100\text{ }^{\circ}\text{C}$ ($-22\text{ }^{\circ}\text{F}$ to $+212\text{ }^{\circ}\text{F}$), special blends remain flexible at low temperatures down to $-55\text{ }^{\circ}\text{C}$ ($-67\text{ }^{\circ}\text{F}$)

70 NBR 150 and 88 NBR 156

As a standard solution, Freudenberg offers within its NBR family the material 70 NBR 150. In addition, the compound 88 NBR 156 is also available as a harder version for special applications.

Application profile

NBR has very good properties in applications with mechanical stress and in oils, fats and waxes. Its temperature resistance in hot water is up to $+100\text{ }^{\circ}\text{C}$ ($+212\text{ }^{\circ}\text{F}$). NBR cannot be used in concentrated acids (e.g. nitric acid, formic acid), concentrated oxidizing media (e.g. peracetic acid), and in aromatic and chlorinated hydrocarbons.

Products and materials

- O-rings made of 70 NBR 150 and 88 NBR 156
- Molded parts made of 70 NBR 150 and 88 NBR 156
- Diaphragms made of 62 NBR 152, 52 NBR 153 and 70 NBR 150
- Clamp seals made of 70 NBR 150

RULES AND STANDARDS	70 NBR 150	88 NBR 156
FDA-compliant (CFR 21 Part 177.2600)	+	+
EU Reg. 1935/2004 EU Reg. 2023/2006	+	+
NSF 61	+	

Download

Data sheet 70 NBR 150



Download

Data sheet 88 NBR 156



HNBR

HNBR (hydrogenated-acrylonitrile-butadiene-rubber) is a material that is generated by full or partial hydrogenation of the double bond-containing butadiene portions of normal NBR polymers. Thus, HNBR offers a similar chemical resistance to NBR, but has better heat and oxidation stability. Furthermore, the material is characterized by high mechanical strength and improved abrasion resistance.

HNBR is often used in dairies, cheese-making facilities and other milk-processing plants, where the fat content of the product to be processed is so high that EPDM is no longer deployable.

General properties

- Partly higher chemical resistance than NBR
- Better heat and oxidation stability than NBR
- High mechanical strength
- Improved abrasion resistance
- Can be used well in water, steam and ultrapure water
- Temperature-resistant from -30 °C to +150 °C (-22 °F to +302 °F)

75 HNBR 231142, 70 HNBR 254067 and 85 HNBR 216553

Application profile

HNBR is very well suited for use under mechanical stress, as well as in oils and waxes, animal and vegetable fats. Moreover, the material is suitable for use in CIP/SIP media with continuously operating plants in the food and pharmaceutical industries. In these processes, diluted acids and alkaline solutions with cleaning additives, as well as disinfectants, steam or slightly oxidizing media or polar and organic solvents, such as acetic acid, are used.

HNBR cannot be used in concentrated acids (e.g. nitric acid, formic acid) and concentrated oxidizing media (e.g. peracetic acid).

HNBR in the beverage industry

Since HNBR has good fat and oil resistance, it is always an interesting alternative material for the beverage industry. The use of essential oils in particular, such as those contained in hops, can be reliably ensured here by HNBR.

Products and materials

- O-rings made of 75 HNBR 231142
- Molded parts made of 70 HNBR 254067 and 85 HNBR 216553
- Butterfly valve seals made of 70 HNBR 254067
- Diaphragms made of 75 HNBR 181070 and 85 HNBR 181071

RULES AND STANDARDS	75 HNBR 231142	70 HNBR 254067	85 HNBR 216553
FDA-compliant (CFR 21 Part 177.2600)	+	+	+

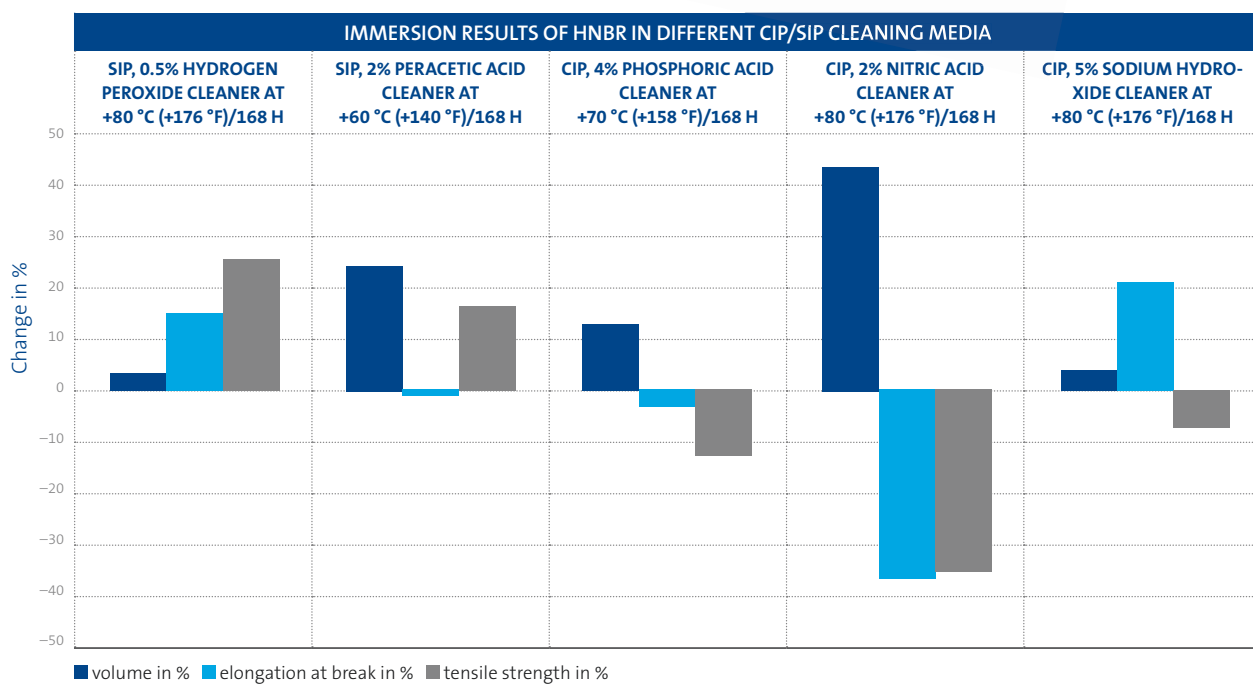

Download
Data sheet 75 HNBR 231142



Download
Data sheet 85 HNBR 216553



Download
Data sheet 70 HNBR 254067



FKM

FKM (fluororubber) is a high-quality material which can be adapted to different applications thanks to its variable composition.

By polymerization of vinylidene-fluoride (VF) and optional use of variable proportions of hexafluoropropylene (HFP), tetrafluoroethylene (TFE), 1-hydropentafluoropropylene (HFPE) and perfluoromethylvinylether (PMVE), it is possible to produce co-, ter- and tetrapolymers with different composition and fluorine contents between 65% and 71%. Thus, the material can be designed for different requirements in terms of chemical resistance and low-temperature flexibility. In the food industry, FKM is used in applications where temperatures above +140 °C (+284 °F) prevail in the process or where media are used which attack other elastomers such as EPDM or HNBR.

General properties

- Excellent temperature resistance
- High chemical stability
- Very good resistance to ozone, weathering, aging and oxygen
- Excellent resistance to mineral oils and fats
- Low gas permeability
- Shows a very good resistance in non-polar media
- Tends toward increased swelling in polar solvents, ketones and amines
- Temperature stability from –25 °C to +200 °C (–13 °F to +392 °F)

70 FKM 37508, 75 FKM 38269 and 75 FKM 180497

Application profile

Fluororubbers with a special composition of the mixture provide excellent resistance in hot water, steam, and alcohols. FKM is very well suited for use in animal and vegetable fats,

oils and waxes, aliphatic and aromatic hydrocarbons, essential oils, and at high temperatures. The material also has good properties in CIP/SIP media for continuous operation plants in the food and pharmaceutical industries. In cleaning processes, it must be taken into account that the use of alkaline solutions, acids and oxidizing media such as peracetic acid is restricted. FKM reacts very sensitively when used with highly oxidizing cleaning agents and disinfectants containing nitric acid, formic acid or peracetic acid. In any prolonged use in alkaline solutions, FKM also loses its stability. However, for short cleaning cycles, this material is still suitable. In the event of doubt, our materials advisory service can assist in finding an optimal materials solution for the individual requirements.

FKM in the beverage and dairy industry

FKM is recommended for both the processing and handling of pure citrus juices and for applications with concentrated essential oils and dairy products. However, a blanket recommendation for use in all flavors and their mixtures cannot be made, because this is an extraordinarily diverse and complex media group. But it is worthwhile to discuss the individual applications with Freudenberg's materials technology experts since FKM is in many cases the more economical alternative to other material solutions.

FKM in the pharmaceutical industry

In the pharmaceutical industry, FKM is employed when non-polar solvents, aliphatic compounds, fats and oils are used. Amines and ketones, however, preclude the choice of FKM materials.

RULES AND STANDARDS	70 FKM 37508	75 FKM 38269	75 FKM 180497
FDA-compliant (CFR 21 Part 177.2600)	+	+	+
EU Reg. 1935/2004	+	+	+
EU Reg. 2023/2006	+	+	+
3-A° Sanitary Standards Class I	+	+	+
USP Ch. 87 (in vitro)	+		
USP Ch. 88 (in vivo) Class VI – 121 °C (250 °F)	+		



FKM in the chemical industry

FKM is in many cases sufficiently resistant to common organic solvents. Especially in contact with alkaline solutions, the material is sensitive; for this reason, alkaline cleaning process should be evaluated on a case-by-case basis.

Due to the variety of possible applications and application parameters, comprehensive technical clarification by our application advisory service is recommended.

Products and materials

- O-rings made of 70 FKM 37508, 75 FKM 38269 and 75 FKM 180497
- Molded parts made of 75 FKM 37508 and 75 FKM 180497
- Diaphragms made of 75 FKM 180497

Download

Data sheet 70 FKM 37508



Download

Data sheet 75 FKM 180497



Download

Data sheet 75 FKM 38269

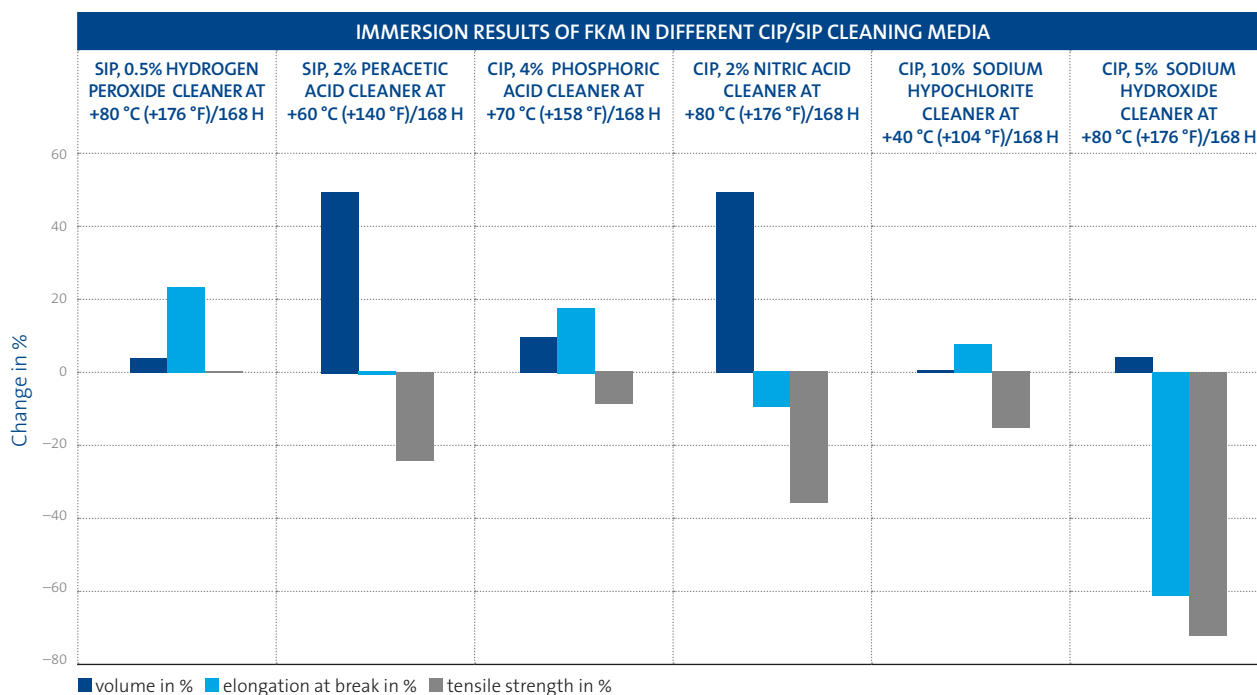

SIMRIZ®

Simriz® perfluoroelastomers (FFKM) are produced using special perfluorinated, completely hydrogen-free monomers, with appropriate compounding and processing techniques. They represent the high-end solution in materials technology.

Simriz® is characterized by a broad chemical resistance similar to that of PTFE, combined with the rubber-elastic properties of an elastomer. With Simriz®, Freudenberg offers a complete range of high-quality FFKM materials. In addition to the Simriz® compounds for standard and high temperature applications, there is a FDA- and USP Class VI-compliant variant, which is ideally suited for use in the food and pharmaceutical industries.

General properties

Thanks to FFKM, utmost temperature and media resistance is not reserved only to PTFE materials with a degree of fluorination of 76%. The operating conditions are limited when using PTFE due to its tendency to cold flow and lack of elasticity. At high pressures and many changes in temperature, pure PTFE seals prove to be unsuitable. Simriz®, on the other hand, combines almost the identical universal resistance of PTFE with the elastic advantages of elastomers.

Therefore, with Simriz® many sealing problems can be solved better and easier. Simriz® also shows very reliable properties in static and dynamic applications, as well as in frequent temperature changes and aggressive media. In addition, Simriz® as FFKM offers the highest degree of fluorination among elastomers. The high bond energy between carbon and fluorine atoms enables excellent resistance to a variety of chemicals with different reactive functional groups and the use in polar and non-polar media, even at high concentrations and temperatures. In addition, the temperature stability with approximately -10 °C to +325 °C (+14 °F to +617 °F) is extraordinarily comprehensive for an elastomer.

75 Simriz® 494 (black) and 75 Simriz® 506 (white)

Application profile

For the prevalent requirements in the food and pharmaceutical industries, Simriz® appears at first glance to be “over-engineered”. However, its cost effectiveness comes to the fore in the holistic view of maintenance and downtime costs which may occur, especially in safety-related applications. Here, Simriz® provides reliability which pays off.

Suitable areas of application

- Water and water vapor
- Concentrated acids (e.g. nitric acid 60%)
- Amines (e.g. ethylenediamine)
- Organic acids (e.g. acetic acid)
- Ketones (e.g. methyl-ethyl-ketone)
- Alkaline solutions (e.g. sodium-hydroxide, potassium-hydroxide)
- Organic solvents (e.g. methanol)
- Aroma concentrates

Simriz® replaces elastomers such as EPDM or FKM when their temperature and media resistance can no longer cope with the demands of the application area, but rubber-elastic behavior is imperative. For example, hygienic design requirements in terms of absence of dead space and good cleanability only leave a minimal margin to the sealing element. Thermal expansion and media swelling must be as small as possible here. Under these stricter requirements with regard to purity and extreme media resistance, even in CIP/SIP processes and at temperatures above +150 °C (+302 °F), Simriz® delivers a high performance that is widely acknowledged in the market.

Simriz® in the beverage industry

Simriz® provides highly-reliable performance, especially for aroma-containing media, and thus safeguards the production process flawlessly.

Simriz® in the chemical and pharmaceutical industries

Simriz® can be used in almost all chemicals. Exceptions are the compounds of the alkali metals.



Products and materials

- O-rings made of 70 Simriz® 491, 75 Simriz® 494, 495, 497 and 506 and 85 Simriz® 496
- Molded parts made of 70 Simriz® 491, 75 Simriz® 494, 497 and 506 and 80 Simriz® 492
- Diaphragms made of 70 Simriz® 491 and 75 Simriz® 494 (on request)
- Butterfly valve seals made of 75 Simriz® 506

RULES AND STANDARDS	75 SIMRIZ® 494	75 SIMRIZ® 506
FDA-compliant (CFR 21 Part 177.2600)	+	+
EU Reg. 1935/2004	+	+
EU Reg. 2023/2006	+	+
USP Ch. 87 (in vitro)	+	+
USP Ch. 88 (in vivo), Class VI – 121 °C (250 °F)	+	+

Download

Data sheet 75 Simriz® 494



Download

Data sheet 75 Simriz® 506

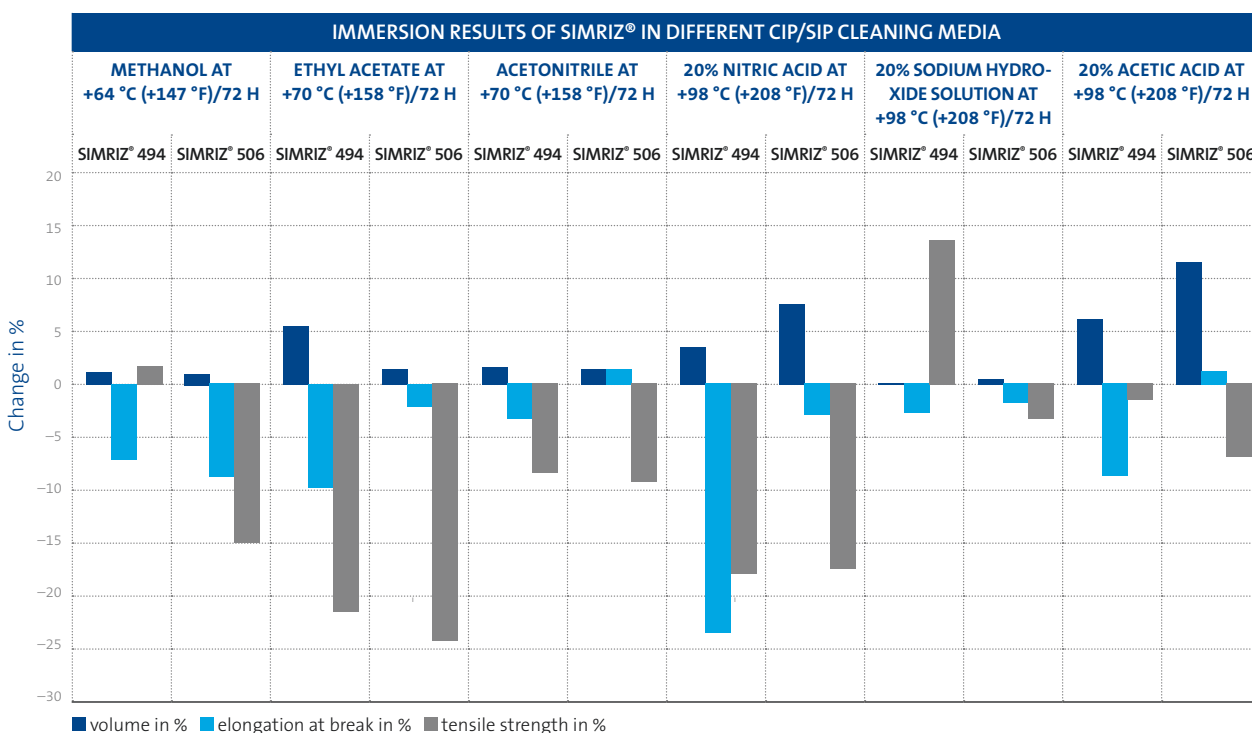

FLUOROPRENE® XP

Fluoroprene® XP is a very highly-fluorinated material with a specific monomer composition. As a result of this, the performance almost achieves the capability of a perfluoroelastomer.

General properties

- Excellent temperature resistance up to +200 °C (+392 °F)
- Very good resistance to ozone, weathering, aging and oxygen
- Excellent resistance in mineral oils and fats
- Low gas permeability
- Very good resistance in non-polar media such as hexane
- Tends to increased swelling in polar solvents (e.g. ethylene-diamine) and ketones (e.g. methyl-ethyl-ketone)

Application profile

Seals made of Fluoroprene® XP are characterized by an excellent and broad resistance. The blue Fluoroprene® XP material thus allows the replacement of EPDM, VMQ and FKM in applications with foodstuffs and pharmaceuticals, as it combines the excellent properties of EPDM materials in polar media (water, acid, alkaline solution) with the excellent performance characteristics of FKM and VMQ types in all non-polar media (fats, oils and hydrocarbons). Its outstanding resistance in steam, hot water, alkaline solutions and acids as well as in non-polar solvents makes it the preferred elastomer for applications with extreme CIP/SIP cleaning media, high temperatures and fat concentrations. Thanks to Fluoroprene® XP, the multiplicity of materials can thus be reduced significantly, which minimizes the complexity and cost of storage and maintenance of plant and equipment on a lasting basis.

Suitable applications for Fluoroprene® XP

- Animal and vegetable fats, oils and waxes
- Aliphatic and aromatic hydrocarbons
- Essential oils and flavorings
- High temperature ranges
- CIP/SIP media for continuous operation plants in the food and pharmaceutical industries
- Oxidizing media (e.g. hypochlorite) or polar organic solvents (e.g. acetic acid)
- Concentrated acids (e.g. nitric acid, formic acid)
- Concentrated oxidizing media (e.g. peracetic acid)

Fluoroprene® XP in the dairy industry

A wide variety of material versions has been used in the dairy industry until now. The EPDM material widely used in the food industry shows indeed the best performance in CIP processes here, but is not usable in every product containing fat. While FKM and VMQ materials are indeed resistant to fat-containing media, they have only limited resistance in the cleaning media customarily available on the market. Fluoroprene® XP was designed specifically for the high demands of the food industry and thus also the dairy industry. It is a 3-A® Sanitary Standards Class I material and can therefore also be used in pure olive oil and in butter with a fat content of 82%. In addition, the material is recommended not only for use in diluted, but also in concentrated CIP/SIP media.

RULES AND STANDARDS	75 FLUOROPRENE® XP 40	75 FLUOROPRENE® XP 41	85 FLUOROPRENE® XP 43	75 FLUOROPRENE® XP 44
FDA-compliant (CFR 21 Part 177.2600)	+	+	+	+
EU Reg. 1935/2004	+	+	+	+
EU Reg. 2023/2006	+	+	+	+
3-A® Sanitary Standards Class I	+	+	+	
USP Ch. 87 (in vitro)		+	+	
USP Ch. 88 (in vivo), Class VI – 121 °C (250 °F)	+	+	+	
NSF 51		+		



Fluoroprene® XP in the pharmaceutical industry

Fluoroprene® XP offers an unbeatable advantage in terms of its excellent resistance to non-polar and oil-based product media compared to EPDM, both in the dairy industry and in the pharmaceutical industry. For instance in the production and packaging of pharmaceutical products such as ointments. The special resistance of Fluoroprene® XP to flavors is also sought-after in ointments containing eucalyptus oil. Fluoroprene® XP is the right choice for a wide variety of oil-containing preparations such as emulsions or sprays, e.g. nasal sprays with essential oils. Both in the synthesis of active ingredients and in their packaging, it is important to keep in mind that the sealing materials release as few substances as possible from their matrix into the product. In order to ensure the purity of the product, analyses of extractables are necessary. Freudenberg examined the range of materials for the pharmaceutical industry in an extractables study. In addition to the EPDM materials, Fluoroprene® XP compounds were also analyzed (see page 61 f.).

Fluoroprene® XP in the beverage industry

While FKM materials swell significantly even at room temperature in aroma concentrates such as “Raspberry” and “Fantasy Fruit”, Fluoroprene® XP provides a good compatibility here. However, there are flavoring agents such as “Peach” where even Fluoroprene® XP reaches its limits, too. Only a perfluoroelastomer can be used here as a stable solution. In the application of the material in concentrations that are common for beverages, Fluoroprene® XP offers a significant advantage, given the limited absorption capacity of flavoring substances (see page 57 f.).

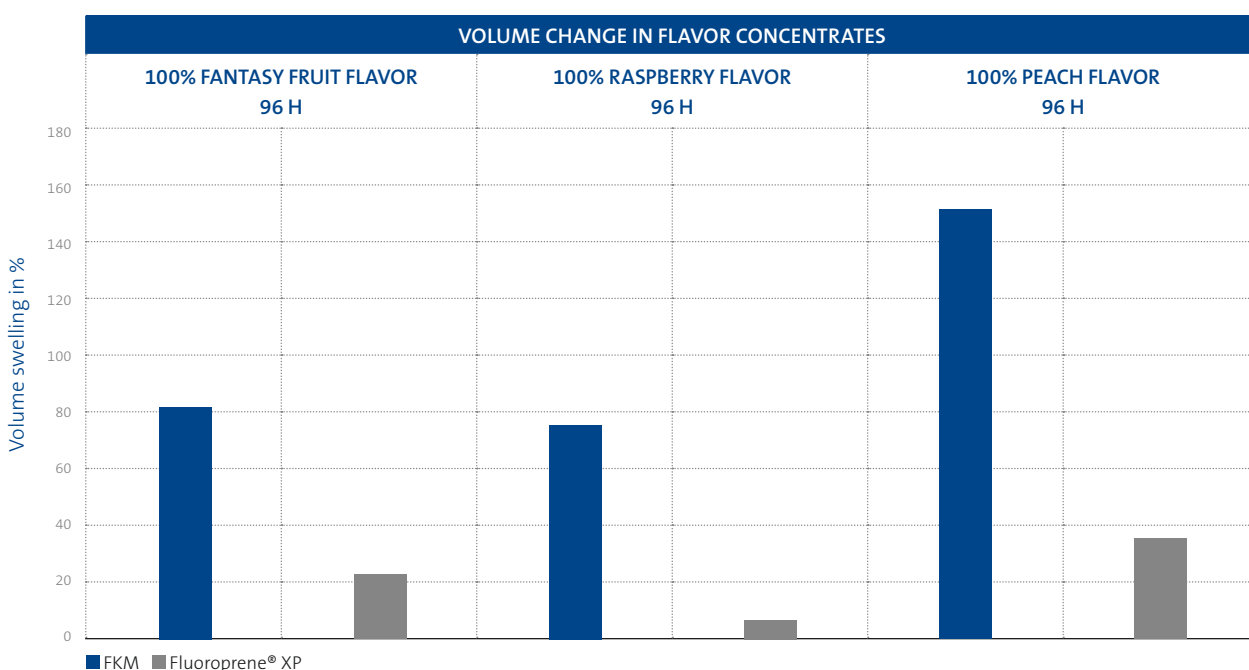

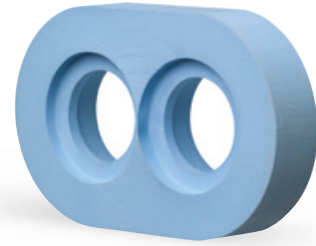

Fluoroprene® XP in the chemical industry

If the resistance of FKM is insufficient and the use of perfluoroelastomers is assessed as not economical, then the material Fluoroprene® XP can be an interesting alternative, provided that the process media used are not too aggressive. Due to the variety of possible applications and parameters, a comprehensive technical clarification is suggested. We recommend that you consult our application advisory service.

Products and materials

- O-rings made of 75 Fluoroprene® XP 40 and 75 Fluoroprene® XP 41
- Molded parts made of 75 Fluoroprene® XP 41 and 85 Fluoroprene® XP 43
- Diaphragms made of 75 Fluoroprene® XP 44 and 75 Fluoroprene® XP 41
- Profiles made of 75 Fluoroprene® XP 41
- Clamp seals made of 75 Fluoroprene® XP 41
- Elastomer bead of the Hygienic Usit made of 75 Fluoroprene® XP 41 (on request)

Download

Data sheet 75 Fluoroprene® XP 40



Download

Data sheet 75 Fluoroprene® XP 41



Download

Data sheet 85 Fluoroprene® XP 43



Download

Data sheet 75 Fluoroprene® XP 44

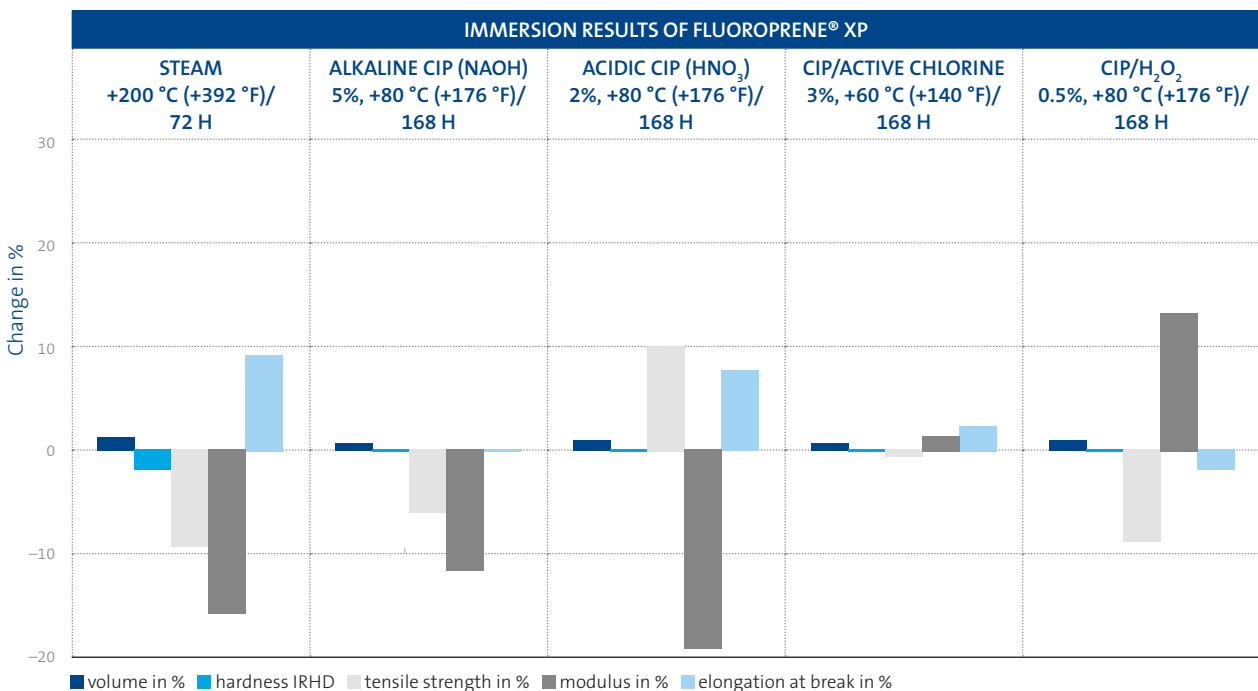

ENGINEERING PLASTICS



OVERVIEW OF ENGINEERING PLASTICS

Engineering plastics have properties that make them ideal for a variety of applications in the process industry. The combination with other substances, such as reinforcing fibers, lubricants or other polymers, can significantly expand the range of possible applications.

It should be noted that thermoplastics, depending on their sophistication, have very different performance limits with respect to temperature, pressure resistance and chemical resistance, which should be taken into account when it comes to their application.

Properties of thermoplastics

- Low density
- Chemical resistance
- High resistance to wear
- Excellent electrical properties
- High energy input capacity
- Very good processing properties

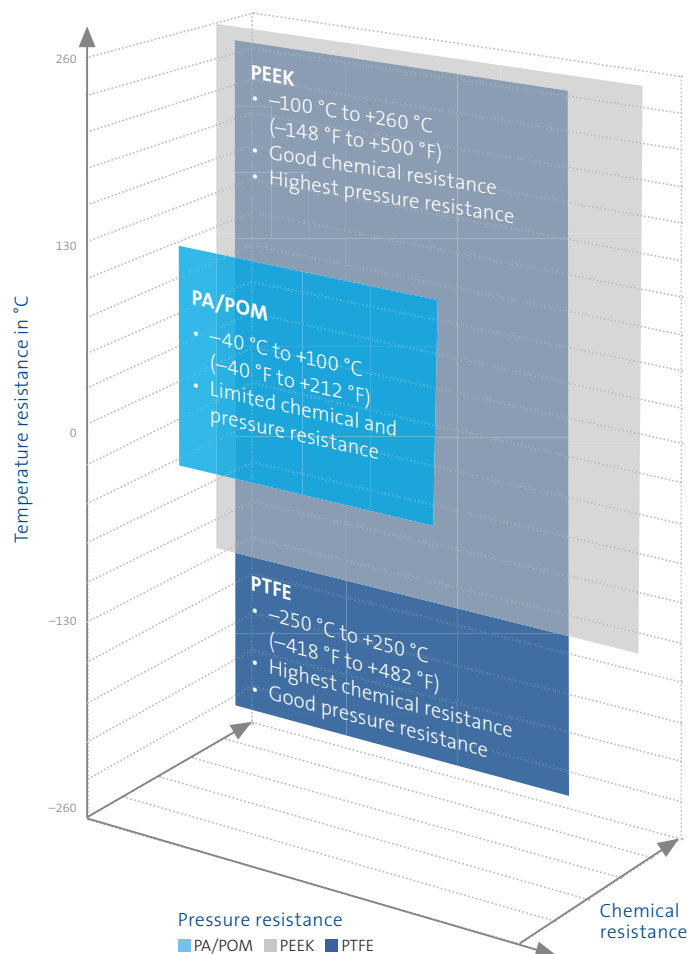

PTFE



Thanks to its composition, PTFE (polytetrafluoroethylene) has a number of excellent properties for the food, chemical and pharmaceutical industries. The chemical resistance exceeds that of all elastomer materials and thermoplastics. Thus, a broad portfolio of applications in almost all media is possible.

The extremely large thermal application range of this material allows it to even be used in contact with liquid gases. It should be kept in mind that the material is not elastic; as such, it cannot simply be used to replace elastomer materials.

The excellent chemical resistance of PTFE is based on the strong bond between the carbon and fluorine atoms, which is due to the strong electronegativity of fluorine. In order to break these bonds, the contacting materials need to use a lot of energy which is not possible in most food and pharmaceutical applications. PTFE is extremely resistant to all acids, bases, alcohols, ketones, benzines, oil and other substances. The material is only non-resistant to very strong reducing agents, such as solutions of alkali metals (e.g. sodium) in liquid ammonia or very strong oxidizing agents, such as elemental fluorine at high temperatures.

PTFE has a very low coefficient of friction. This means that it glides as well over PTFE as wet ice over wet ice. In addition, the static friction is equal to the dynamic friction, so that the transition from standstill to movement takes place without jerking. The “stick-slip” effect is thereby prevented.

There are almost no materials that adhere to PTFE, since its surface tension is extremely low. The surface may be prepared for bonding by targeted etching.

General properties

- Density: 2.10 to 2.30 g/cm³
- Hardness 55 to 60 Shore D
- The thermally reliable application range of PTFE is between –200 °C and +250 °C (–328 °F and +482 °F). At temperatures above +400 °C (+752 °F), highly toxic pyrolysis products such as fluorophosgene (COF₂) are released
- Special types of PTFE can be welded
- To a certain degree, PTFE has an innate memory-effect, which means that it seeks to go back to its original shape. This is based on the extremely long chains of molecules that build up PTFE

Products

- Rotary shaft seals
- Bellows
- U-packings
- Slide bearings
- V-Seal set packings
- O-rings

Optimization possibilities of PTFE

Unfilled PTFE as a base material has some disadvantageous properties, such as poor cold flow behavior, relatively low wear resistance, low resistance to high-energy radiation and poor adhesion behavior. All of these can be eliminated by the addition of various additives.

Reasons for admixing fillers in PTFE:

- The wear resistance is increased many times over
- The resistance to creep or deformation under load is increased to a multiple of the original value
- Depending on the filler, the thermal conductivity can be increased significantly
- The thermal expansion is reduced
- If necessary, the electrical properties of PTFE can be changed by appropriate filler selection
- The choice of filler also influences the wear behavior of the opposing surface

Processing of PTFE

PTFE cannot be processed by injection molding. For the production of components, different compounds, depending on the desired properties, can be used to produce semi-finished products (pipes, rods and plates), which are further processed into finished products in a subsequent processing step.

MATERIAL			PTFE VIRGIN	PTFE + GLAS FIBER	PTFE + CARBON	PTFE + CARBON FIBER	PTFE + BRONZE
PROPERTIES	TEST STANDARD	MEASURING UNIT					
Filler content		% of weight		25.0	25.0	10.0	40.0
Density	ASTM D792	g/cm ³	2.15	2.22	2.10	2.03	3.0
Ball indentation hardness	DIN 2039-1	N/mm ²	27.0	34.0	37.0	35.0	41.0
Tensile strength	DIN 12086-2	MPa	PR 29/UR 33	PR 14/UR 17	PR 12/UR 16	PR 18/UR 19	PR 24/UR 25
Elongation at break	DIN 12086-2	%	PR 354/UR 357	PR 353/UR 356	PR 120/UR 170	PR 307/UR 295	PR 343/UR 293
Tensile modulus of elasticity	In-house standard T= +40 °C (+104 °F)	MPa	PR 446/UR 383	PR 674/UR 752	PR 925/UR 959	PR 673/UR 670	PR 760/UR 771
Deformation under load at +23 °C (+73 °F), 24 h, 15 N/mm ²	comp. to ASTM D621	%	PR 13.8/UR 16.4	PR 11.6/UR 13.9	PR 7.0/UR 6.3	PR 11.9/UR 13.0	PR 8.4/UR 9.1
Irreversible deformation	comp. to ASTM D621	%	PR 7.0/UR 8.3	PR 6.2/UR 7.8	PR 3.2/UR 2.8	PR 5.9/UR 6.8	PR 4.1/UR 4.8
Tensile yield point 1%	ASTM D695	MPa	PR 11.0	PR 12.5	PR 13.7	PR 11.9	PR 13.1
Tensile yield point 5%	ASTM D695	MPa	PR 15.7	PR 16.8	PR 19.6	PR 16.8	PR 19.1
Surface resistance	ASTM D257	Ω	> 10 ¹⁷	> 10 ¹⁵	> 10 ²	> 10 ¹⁰	> 10 ¹²
Thermal conductivity	ASTM 1461	W/m·K	0.24	0.30	0.68	0.37	0.47
Coefficient of linear expansion at +50 to +100 °C (+122 to +212 °F)	DIN 53752	10 ⁻⁵ ·K ⁻¹	10.6	9.8	8.2	11.7	8.8

PR = Pressing direction, UR = Circumferential direction

ePTFE

ePTFE is an expanded PTFE material with improved mechanical properties as a result of the multi-directional alignment of the polymer chains.

Freudenberg's FG-360 has a denser form and therefore offers better stability and even less creep relaxation and cold flow than existing expanded PTFE products. This eliminates the need for a reinforcing effect by means of fillers and binding agents. FG-360 is thus a 100% pure ePTFE - without additives.

Because of its purity, the material can be used in the biotechnology and pharmaceutical industry without concerns. Damaged or worn flange surfaces are easily offset by this material. It is a soft, extremely compressible and at the same time very strong material that has excellent sealing properties even at low surface pressures and tightening torques.

Due to the impermeability effect at low surface pressures, it is ideally suited for plastic and glass-lined flanges. Its low friction coefficient of 0.2 (similar to wet ice) allows easy installation and dismantling. ePTFE has an unlimited shelf life because it does not embrittle or age. This material is resistant to UV radiation, ozone and almost all chemicals. It is very easy to cut or punch by hand.

General properties

- Well-suited for applications in the temperature range from -200 °C to +300 °C (-328 °F to +572 °F)
- Usable in the pressure range from vacuum to 200 bar
- Chemically inert over the pH range from 0 to 14
- FDA-compliant
- USP Ch. 88 Class VI-121°C (250 °F)

Products

- FG-360 Joint Sealant is a sealant tape with adhesive strips on the back for ease of installation. It is an excellent product for heat exchangers, irregular flanges, fuel caps, man-holes and hand holes
- FG-360 Seal Plates are produced in 1.5 mm, 2 mm and 3 mm plate thickness. The panel size is 1,500 mm x 1,500 mm. Other thicknesses are also available on request
- FG-360 Packing Cord is a round cord pack that does not harden in use. It is suitable for almost all conceivable applications. The low friction coefficients ensure the valve function even after a long period of inactivity. Packing cords are available as standard sizes with a diameter of 2 mm to 25 mm

PROPERTIES	1.5 MM THICK	3.0 MM THICK
Type	TF-0-0 DIN 28091-3	TF-0-0 DIN 28091-3
Color	white	white
Rules and standards	<ul style="list-style-type: none"> • FDA 21 CFR 177.1550 • USP Ch. 88 (in vivo), Class VI - 121 °C (250 °F) • TA Luft 	<ul style="list-style-type: none"> • FDA 21 CFR 177.1550 • USP Ch. 88 (in vivo), Class VI - 121 °C (250 °F) • TA Luft
Density g/cm ³	0.85	0.85
Tensile strength longitudinally N/mm ²	14	18
Compression %	69	66.2
Resilience %	7.6	11.6
Temperature range	-268 to +315 °C (-450 to +599 °F)	-268 to +315 °C (-450 to +599 °F)



POM, PA, PU, PEEK

POM – Polyoxymethylene

Polyoxymethylene (POM, also called polyacetal) is a semi-crystalline thermoplastic. POM has been on the market since 1956 and is used especially for precision parts because of its high rigidity, low friction coefficients and excellent dimensional stability. POM is characterized by high stability, hardness and rigidity over a wide temperature range. It retains its high strength even at low temperatures down to $-40\text{ }^{\circ}\text{C}$ ($-40\text{ }^{\circ}\text{F}$). Its natural color is opaque white due to high crystallinity, but the material can also be dyed in all muted colors. POM has a density of $\rho = 1.41$ to 1.42 kg/m^3 . The water absorption factor is so low that it is of no importance for its use: at standard climatic conditions about 0.2%, and at full saturation with water at $+23\text{ }^{\circ}\text{C}$ ($+73\text{ }^{\circ}\text{F}$) only about 0.8%. The physical characteristics of the molded parts thus vary only slightly.

The good chemical resistance and low water absorption predestine POM for use in contact with food. Many types are FDA-compliant. Due to its high crystallinity, POM is more rigid and firmer than other thermoplastics, especially in the temperature range of $+50\text{ }^{\circ}\text{C}$ to $+120\text{ }^{\circ}\text{C}$ ($+122\text{ }^{\circ}\text{F}$ to $+248\text{ }^{\circ}\text{F}$). POM has a clearly defined tensile yield point at about 8% elongation at room temperature. Below this yield point, it demonstrates good resilience even under repeated stress and is therefore particularly well-suited for elastic elements. The high creep rupture strength and low tendency to creep round off the benefits of POM.

Suitable areas of application

The mechanical properties of POM in conjunction with good friction and wear performance make this material predestined for a wide range of engineering applications.

Products

- Molded parts
- Backup rings
- Guide rings

PA – Polyamide

Most commercially important polyamides are partially crystalline, thermoplastic polymers. They are characterized by high strength, stiffness and toughness, and have good chemical resistance and workability. The properties of the polyamides are largely dominated by the amide groups, which interact with each other via hydrogen bonds. Polyamides have a high wear resistance and good sliding properties. The mechanical properties can be further improved by means of fiber composites with glass or carbon fibers so that, for example, strength and impact resistance can be adjusted to suit the application.

Suitable areas of application

PA is distinguished by its high strength values as an ideal material for use in mechanical elements such as gears, friction bearings or guide rails. In the sealing area, PA rings are often used as backup rings for a wide variety of sealing elements. PA is characterized in particular by:

- High wear resistance
- Good damping power
- Good dry running characteristics
- Low tendency to creep and
- Low water absorption PA6: 2.5% – 3.5%
- PA12: 0.2% – 0.5%

Products

- Backup rings
- Guide rings



PU – Polyurethane

Polyurethane (PU or PUR) is a plastic that can be processed with almost all methods of plastics technology. Polyurethanes are linear or cross-linked high polymers that are formed by the reaction of di- or polyisocyanates and hydroxyl carriers such as polyols, chain extenders and cross-linkers and potentially other components. Common to all of them is the urethane bond created by this reaction, which gives the name to this material group. Thanks to the highly polar urethane group common to all polyurethanes, this plastic is characterized particularly by:

- High tensile strengths (far in excess of 60 MPa)
- High elongations at break (in some cases more than 1,000%)
- Elasticity
- Abrasion resistance
- Oil resistance
- Ozone resistance

Suitable areas of application

Using special raw materials, it is possible to achieve good hydrolysis, acid and alkali resistances as well. Polyurethanes cannot be used in contact with amines, glycols and chlorinated solvents. Since the urethane group is non-toxic and biologically very compatible, polyurethanes are especially well-suited for drinking water and food applications in compliance with KTW and FDA standards. A high-quality subgroup of the polyurethanes are the thermoplastic polyurethanes. These often expensive granulates can be processed into extremely high-quality components, e.g. by means of injection molding or extrusion processes, with reasonable processing costs.

Products

- U-packings
- Wipers

PEEK – Polyetheretherketone

PEEK (Polyether-ether-ketone) has a similar chemical resistance to PTFE, but with improved mechanical properties. This material is renowned for its almost universal chemical resistance and high temperature resistance (+260 °C/+500 °F continuous operating temperature) and is therefore growing in popularity.

Suitable areas of application

While only of limited use in seals due to its lack of elasticity, PEEK is increasingly finding application opportunities as a backup ring for O-rings under high pressure, or in V-Seal set packings as backup rings or compression rings. Unfilled PEEK is FDA-compliant, but there are also options here to modify the mechanical properties by means of fillers such as glass fiber and carbon fiber or PTFE. In contrast to PTFE, PEEK can also be processed by injection molding.

Products

- Backup rings for O-rings
- Backup rings in V-Seal set packings
- Compression rings in V-Seal set packings



**MATERIALS RESISTANCE
AND PURITY**

TEMPERATURE AND FAT RESISTANCE

Seals are used in a broad variety of media, resulting in very specific operational conditions. Depending on the duration and nature of their exposure to these media, aging processes in the elastomer trigger changes that could lead to hardening or softening. This is reflected, for example, by swelling, cracking and brittleness or discoloration of the material. The higher the temperature, the faster aging proceeds.

During contact with the media, there are always two different processes impacting the elastomer material which may affect physical swelling and chemical reaction. In contrast to pure swelling, the chemical processes are irreversible. In general, the chemical principle is “like dissolves like”. This means that polar elastomers swell in polar media and non-polar elastomers are only conditionally stable in non-polar media. No single elastomer can be used universally. The requirements with respect to media resistance and the lower and upper temperature limits must be taken into account and then be used together with the specific application to select the most suitable material.

Elastomeric materials

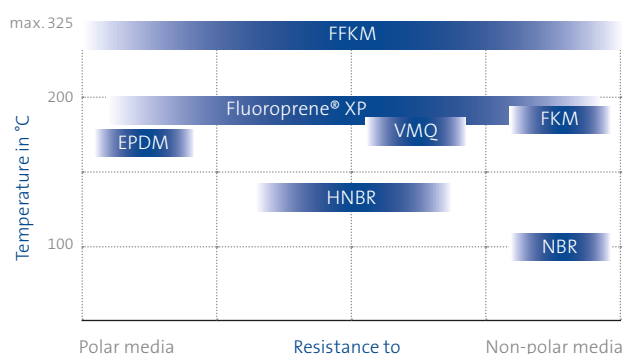

Aging and viscous flow

Diagram 1

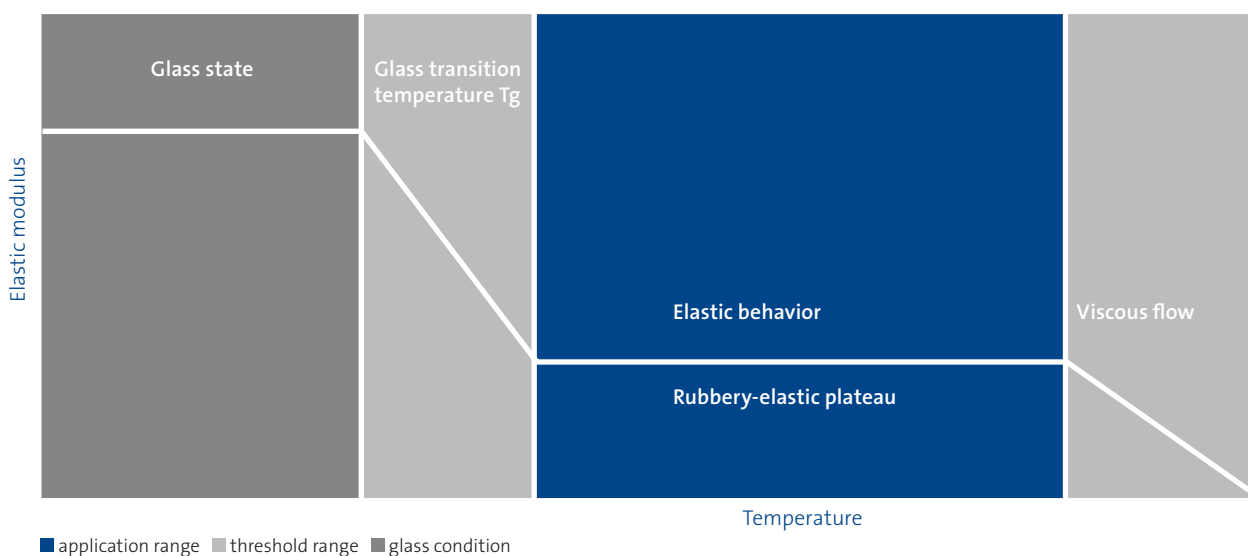

Temperature and fat resistance

The temperature significantly affects the physical properties of rubbery-elastic materials. If the modulus of elasticity (E-modulus/elastic modulus) is considered in relation to the temperature, a constant E-modulus at a high level and at a low temperature is visible, which identifies the glassy state. As the temperature rises, the area of the glass transition is entered where the elastic modulus drops sharply. A constant level follows subsequently. The rubbery-elastic plateau, where the material displays elastic behavior, represents its application range as a sealing material. If the temperature rises further, the modulus of elasticity drops, indicating aging or viscous flow of the material (diagram 1). The transition from the rubbery-elastic state to the glassy state is particularly important because in many cases it represents the lower limit of the possible operating temperature. Depending on the stress, the actual operating limit for the specific application is slightly higher (at the beginning of the glass transition range) or slightly lower (at the beginning of the glassy state). Simply stated, this means that in static applications elastomers can be used at lower temperatures than in dynamic applications. Diagram 2 shows an overview of the thermal application ranges of various types of elastomers. The grey areas indicate temperature application ranges to which standard types may only be exposed.

Although fat causes problems for many sealing materials, it is in the traditional sense not an aggressive medium. In processing plants for the food industry, about 70% of the seals used are made of EPDM. Only if EPDM cannot be used, as is the case with products with a high fat content, must an alternative be found. The use of other materials may have disadvantages such as a change of the cleaning cycle, higher costs and additional storage overheads. In the past, EPDM was not used at all in the dairy industry. Today's technologically advanced EPDM materials demonstrate a significantly better performance and are quite usable in many applications – despite fatty products. If EPDM seals are to be used, there are different upper temperature limits for various kinds of products containing fat:

- Milk with 3.5% fat content can be processed up to a temperature of +80 °C (+176 °F).
- For cream with 30% fat content, the temperature limit is already reached at +35 °C (+95 °F).
- Butter with 82% fat content can only be processed up to a maximum of +8 °C (+46 °F).

The diagram on page 35 illustrates the use of EPDM as a function of fat content and temperature. EPDM is applicable below the line; above it Fluoroprene® XP should be used if there are no restrictions regarding the cleaning process.

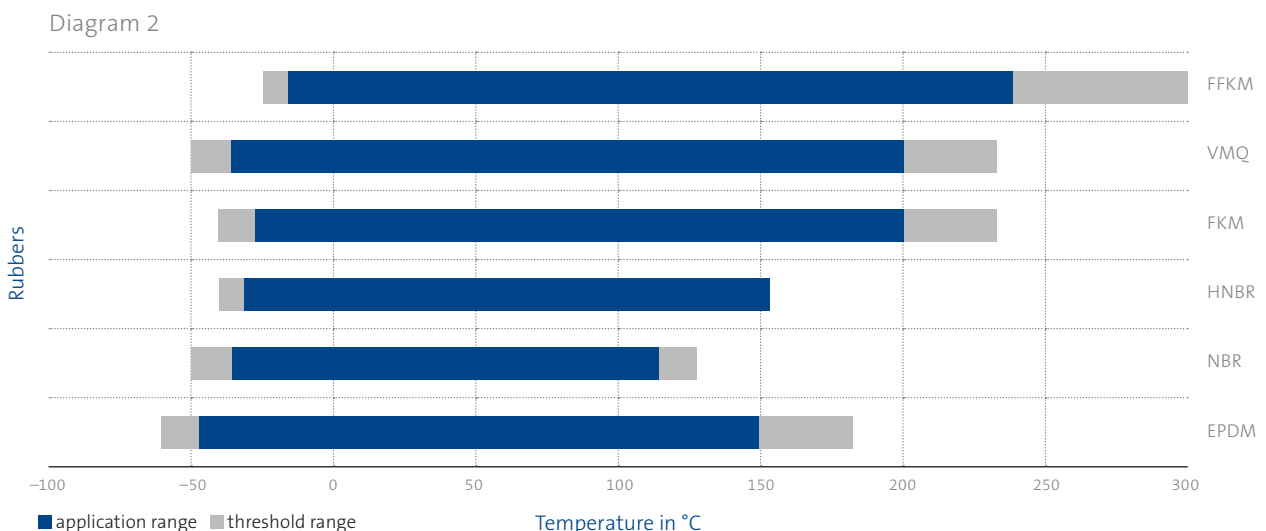

FLAVORING AGENTS

In addition to the demanding cleaning processes, flavoring agents in the food industry require an equally careful selection of the right material. The various flavors affect the material resistance very differently. Especially peach and tropical fruit flavors as well as orange oil can result in problems with regard to material resistance.

Flavoring agents consist of various chemical ingredients. Therefore a classification based on their elastomer-destroying potential is difficult, even more difficult than for CIP cleaning agents, for example. In addition, the ingredients which are dangerous for elastomers may potentiate their effect or, conversely, may greatly attenuate each other. It is very difficult to gain systematic knowledge here.

Traditionally, FKM is used in these media because FKM has excellent resistances to aliphatic and aromatic hydrocarbons as well as oils and fats. FKM can also be used in media such as essential oils and citrus flavorings, whereas EPDM swells a lot due to its high proportion of non-polar ingredients. Since most flavoring agents in addition contain aldehydes, ketones and carboxylic acids, which are known to be harmful to elastomers, there is sometimes no other

alternative but to resort to FDA-compliant perfluoro-elastomers. Fluoroprene® XP, with its significantly better chemical resistance compared to an FKM, can be an interesting alternative to this solution.

At any rate, what is important in terms of reliable material recommendations are well-grounded resistance tests. In order to be able to make a reliable assessment of the suitability of an elastomer, not only should the physical influences through the usual tests of mass and volume changes be used here, but also the no less hazardous chemical effects of the media on the mechanical properties of the material. These can be determined through comparative measurements of elongation at break, 100% modulus and tensile strength. Because even in dilutions as low as one tenth of one percent, flavoring agents may lead to partly fatal changes in the tensile strength of elastomers.

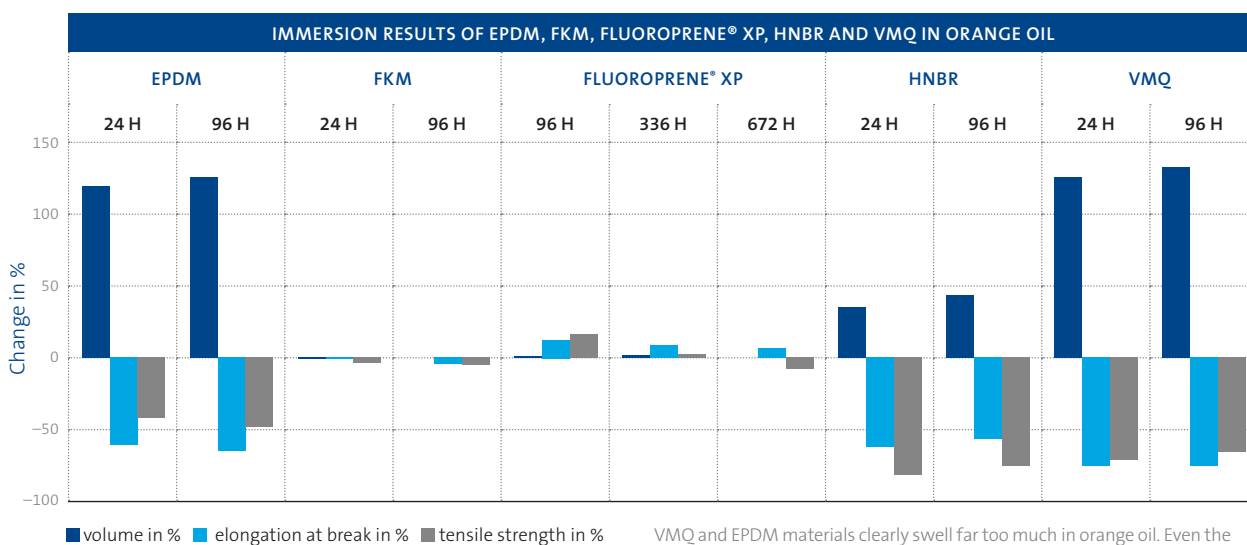

VMQ and EPDM materials clearly swell far too much in orange oil. Even the swelling behavior of HNBR exceeds the tolerable limit. Fluororubbers, on the other hand, are very resistant.

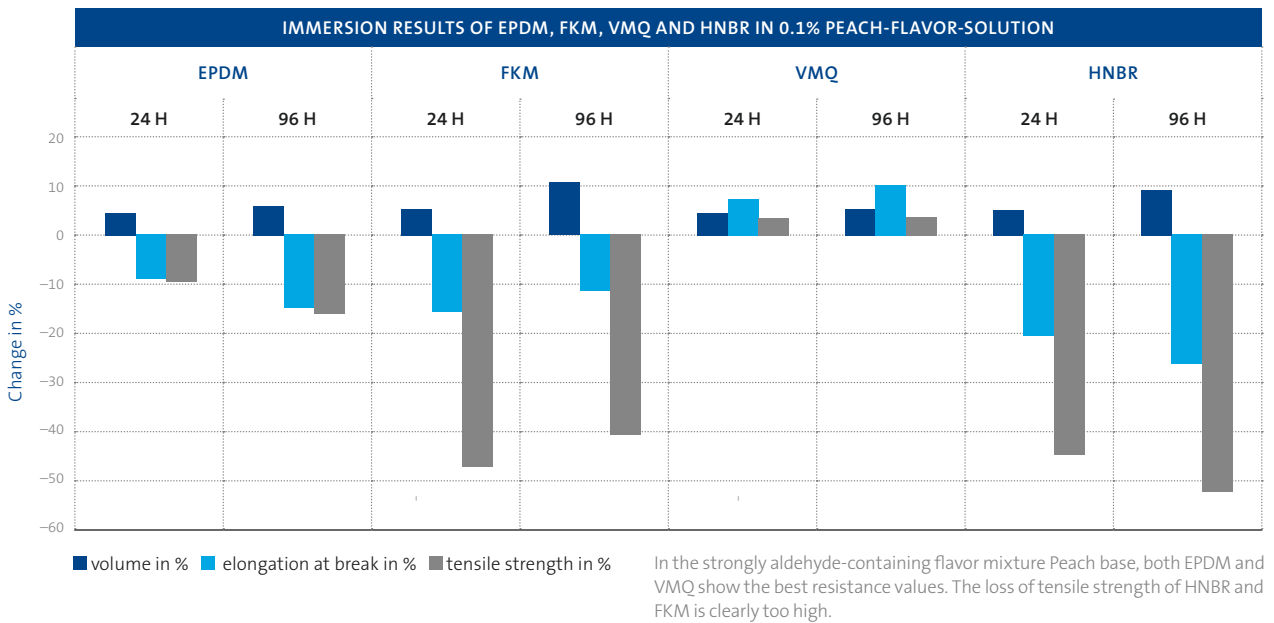
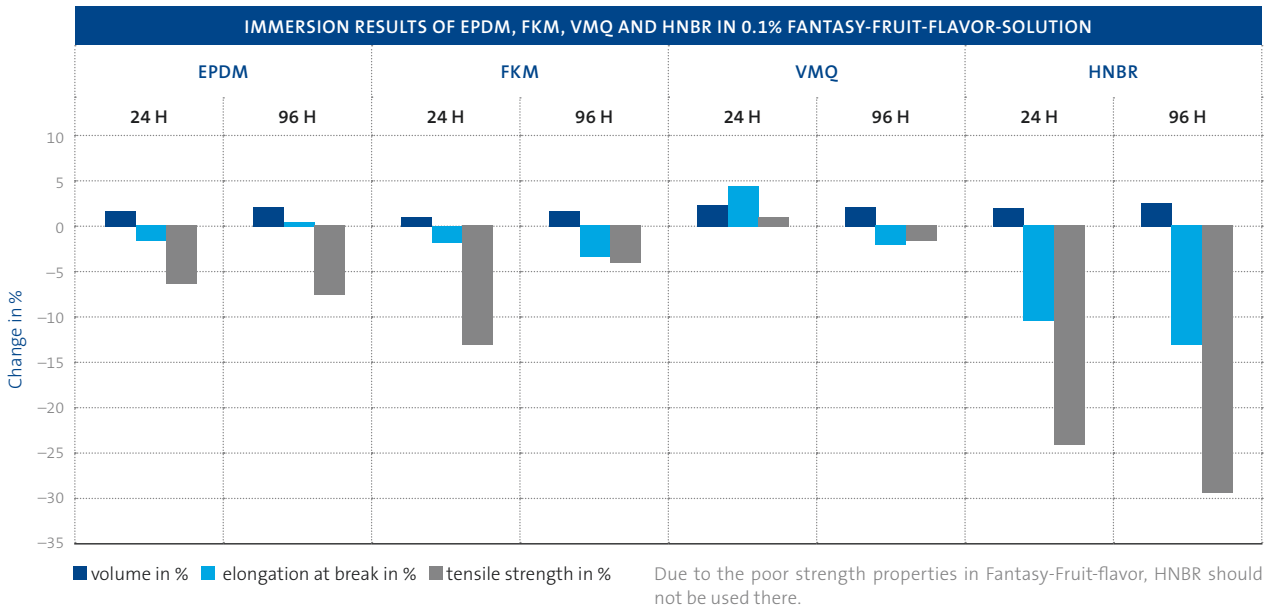

Flavor carry-over

Flavor transfer or flavor carry-over is a well-known problem in beverage bottling. The seals absorb the ingredients of the flavoring mixture during the bottling of a flavored drink and gradually release them again during the next bottling process for another product. This may well go unnoticed if the products bottled successively are both flavored and one of the products merely has a slightly stronger raspberry taste, for example. It is different when after a slightly flavored water (so-called near-water products), the thus far flavorless mineral water is bottled and the subsequent batch has unintentionally absorbed a peach or cherry flavor, for example. In order to find the most suitable material for this application, different materials were analyzed by Freudenberg with respect to their flavor absorption and release capacity.

Studies by Freudenberg related to the flavor carry-over of different materials, such as EPDM, FKM and Fluoroprene® XP, have shown that EPDM materials absorb and release flavor the most. The remigration rate of an EPDM material is 100 times greater than the uptake and release capacity of Fluoroprene® XP. In addition, the fluorinated material does not absorb all the components of the flavor mixture in equal measure. After the investigation, it turned out that the esters present in the flavor mixture could not be detected, i.e. that they had been absorbed by Fluoroprene® XP at a small, undetectable rate. However, the ketones migrated into the elastomer matrix and decreased by half after the cleaning step. In bottling establishments where multiple products of different flavor intensity are bottled on the same bottling line, it must be ensured that the quality of the product made remains constant after each production cycle and is not contaminated by the flavoring agents from the batch that was bottled last. Due to the negligible absorption of flavoring substances, the Fluoroprene® XP materials portfolio qualifies as especially suitable for such applications.

Washing-out test EPDM/Fluoroprene® XP 40

First rinse cycle EPDM assumed as 100%

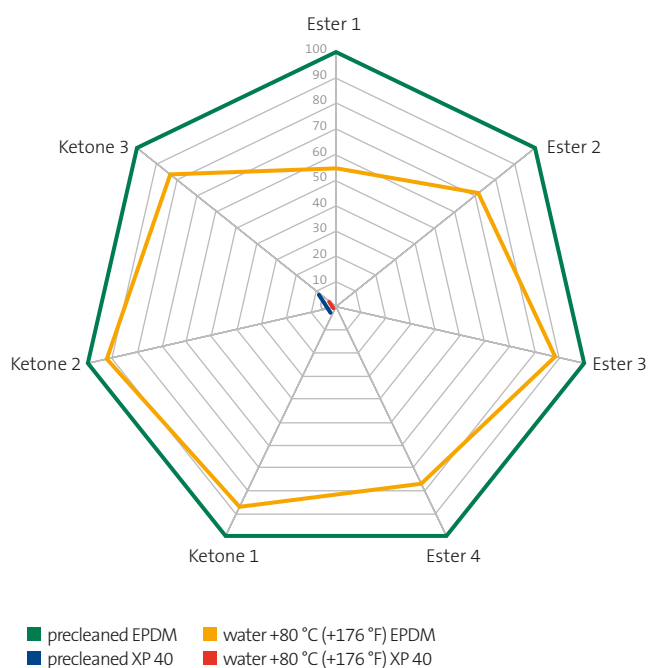

CLEANING PROCESS

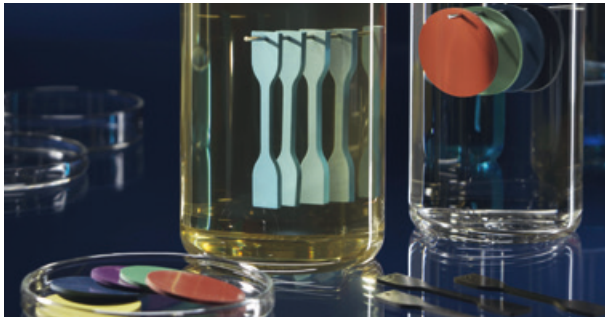

Among the most important requirements when designing a seal is not only the resistance of the sealing material to the product itself in which the seal is used, but also the compatibility with various cleaning agents and steam temperatures of up to +140 °C (+284 °F). The aggressive cleaning media on the basis of acid, alkali and peroxides pose to some extent even greater challenges for the sealing materials than the product medium itself. In addition, the high cleaning temperatures exacerbate the effects of the media on the material.

The cleaning methods at a glance

- CIP (“Cleaning In Place”) is the fully-automatic cleaning without disassembly of the equipment
- COP (“Cleaning Out of Place” or “Cleaning Open Plant”) refers to cleaning after disassembly, opening of the plant, etc.
- SIP (“Sterilization In Place”) is the sterilization, either with peracetic acid, hydrogen peroxide (“cold sterilization”), or with hot steam
- WIP (“Washing In Place”) requires partly manual work (brushing, scrubbing etc.) in some places
- WOP (“Washing Out of Place”) means the complete dismantling and cleaning of the plant by hand
- OPC (“Open Plant Cleaning”) is the external cleaning of a plant without disassembly

A typical cleaning procedure consists of seven steps:

1. Pre-rinsing to roughly remove product residues (with cold or warm water, depending on the product)
2. Cleaning with an alkaline cleaner (sodium or potassium hydroxide), plus various additives (surfactants, complexing agents, anti-foaming agents etc.)
3. Flushing out the alkaline detergent with water
4. Acidic cleaning to remove, e.g. limescale (phosphoric acid or nitric acid as well as additives)
5. Flushing out the acid with water
6. Disinfection for elimination of microorganisms (peracetic acid and/or hydrogen peroxide mixtures, alternatively using steam)
7. Final rinsing with water of drinking water quality or higher, depending on the application

EXTRACTABLES

Particularly high purity requirements apply to elastomers in the pharmaceutical industry, including the desire for disclosure of the ingredients of the compounds. This does not provide the desired information about the interactions that can take place during the production process.

That is why manufacturers in the pharmaceutical industry want to examine materials for a possible interaction with the pharmaceutical preparation. For example, they want to know how an O-ring for the sealing of an inhalation spray head behaves in contact with the drug. It is also of interest to minimize the influence of the seals from production on the product. In addition to studies at ambient temperatures – with respect to the completeness of the packaging, the storage conditions and test substances (leachables study) – tests are slated in the worst-case scenario with more stringent conditions such as elevated temperatures and solvent strengths (extractables study). Apart from the quantification, the identification of the migrated substances is particularly important for a subsequent toxicological evaluation.

Compared to storage, a multiple of the volume flows by the seal in the production process. The ratio of surface area to volume and hence the concentration of possibly leached compounds is therefore much smaller. Nevertheless, an interaction between the sealing material or the soluble components of the elastomeric compound and the active pharmaceutical ingredient can occur. This interaction might alter the pharmaceutical product and, in the worst case, adversely affect its efficacy. If the interactions between the seals in valves and other system components and the products therein are known to the pharmaceutical manufacturers, possible contamination can already be evaluated during the production process. This safeguards the processes and ensures the necessary purity of the products.

Extractables study

Freudenberg conducted an extractables study on O-rings with different media at high temperatures.

DESIGNATION	COLOR	HARDNESS SHORE A
EPDM 291	black	70
EPDM 292	black	85
EPDM 253815	white	70
Fluoroprene® XP 41	blue	75
Fluoroprene® XP 43	blue	85
Simriz® 494	black	75
Simriz® 506	white	75

The tested O-rings were extracted, without prior cleaning steps, in a low ratio of elastomer to extract medium for 24 hours under reflux to achieve the most stringent conditions possible for evaluation. To ensure the comparability of results of different O-rings, the ratio between surface and media volume was kept constant. In line with the recommendations of the FDA, the BfR and other relevant sources, four media were used:

- Ethanol
- N-hexane
- Phosphate buffer pH 2.5
- Phosphate buffer pH 9.5

In addition to a gravimetric evaluation, the extractable contents were analyzed by means of gas chromatography-mass spectrometry (GC-MS). For this purpose, the evaporated extracts were absorbed in the respective extracting agent and the extracts of the buffer solutions in methanol and injected into the gas stream. The chromatograms were plotted with the same scale size for evaluation. The sum of the detected substances was assessed by an evaluation of the entire surface and by the determination of the main compounds found.

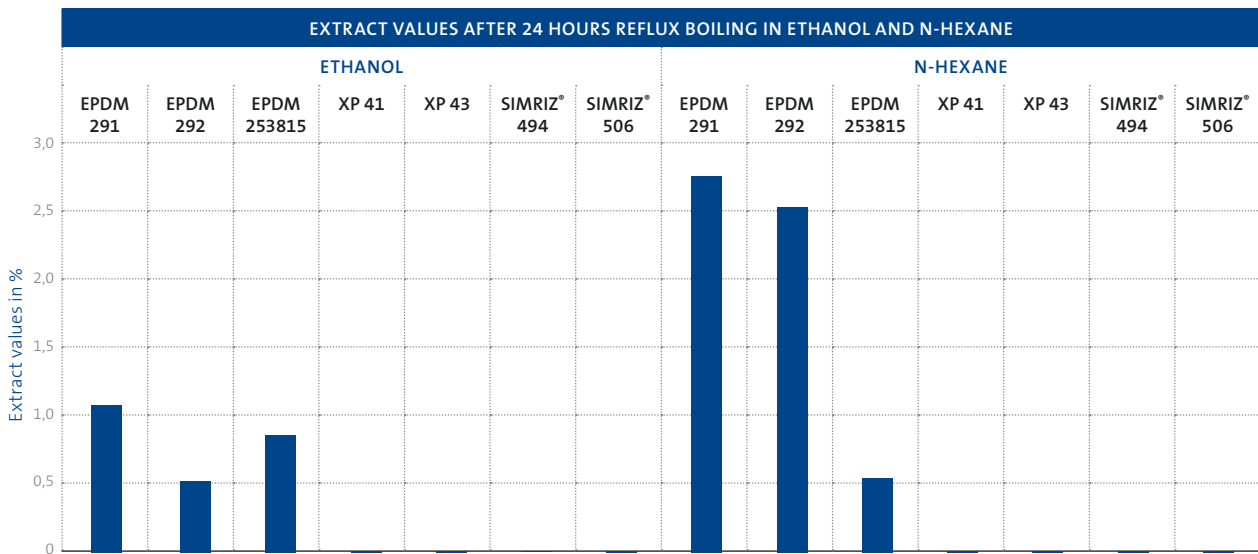

In addition, Total Organic Carbon (TOC) studies were performed on the extract solutions of the phosphate buffers as a measure of the organic contamination. The TOC amount

found in the liquid sample was again quantitatively assessed in comparable proportion to the elastomer sample.

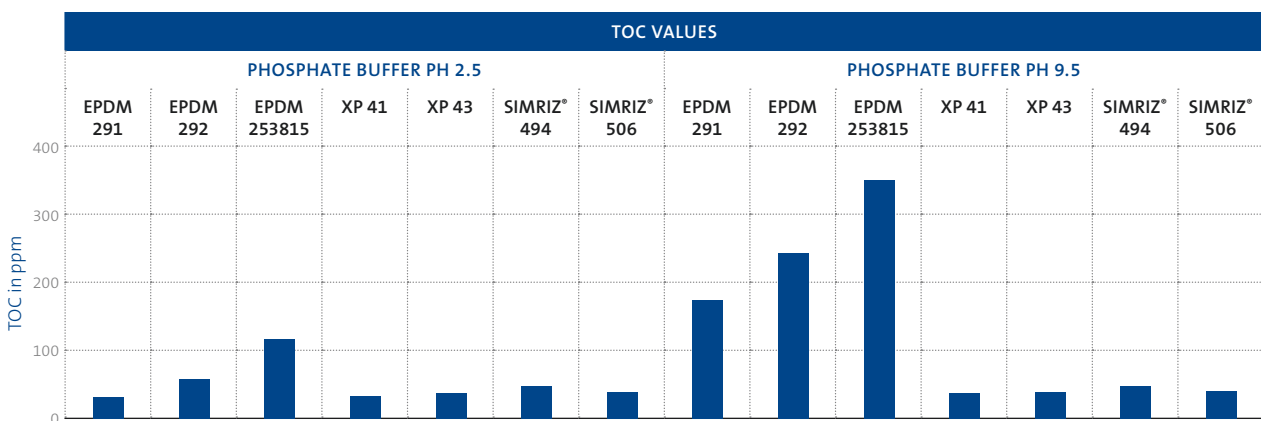

The present extractables study offers two main advantages. Firstly, Freudenberg customers can request the extract values and the evaluation of the leached chemicals and use them for their own leachables studies. This saves time and money, as the leachable chemicals have already been identified and can

be incorporated into one's own leachables study. Furthermore, in the case of batch contamination, it is possible to use the Freudenberg database results for risk assessment and for decision-making on the batch.

HYGIENIC DESIGN

In sterile technology, there is a rule that a seal must be installed free of dead space and leaks. The groove must be 90% filled and the material must not have any swelling greater than 5%, otherwise gap extrusion will allow sealing material particles to contaminate the process medium.

The resistance of the sealing materials, taking into account the production, CIP and SIP parameters and the requirements of Hygienic Design, must be ensured. The elastomer materials that come into contact with the actual product

must be sufficiently resistant to preclude their breakdown – in production or in cleaning and sterilization cycles – and the subsequent possibility of a deterioration of the product quality as a result of foreign matter stripped or dissolved from the interior of the plant.

CLASS DETAIL	PRODUCT	OPERATING CONCENTRATION (%)	TEMPERATURE	EXPOSURE TIME (MIN.)
CIP or circulation cleaners containing nitric acid and surfactants	Acidplus VA 35	0.5 – 2.0	+20 to +80 °C (+68 to +176 °F)	Not specified
CIP or circulation cleaners containing formic acid and surfactants	Beta VA 11	0.5 – 3.0	+10 to +70 °C (+50 to +158 °F)	30 – 60
CIP or circulation cleaners containing phosphoric acid and surfactants	Divbrau VA 10	1.0 – 4.0	+10 to +70 °C (+50 to +158 °F)	20 – 60
Phosphoric acid-based foam cleaners	Acifoam VF 10	3.0 – 10.0	+20 to +40 °C (+68 to +104 °F)	Not specified
Alkaline, single-phase cleaners containing EDTA for circulation cleaning	Solo VC 27	0.5 – 5.0	+40 to +80 °C (+104 to +176 °F)	Not specified
CIP or circulation cleaners containing bases and surfactants	Highstar VC 77	0.5 – 5.0	+40 to +80 °C (+104 to +176 °F)	Not specified
Alkali gel cleaners	Powergel VG 1	2.0 – 10.0	+20 to +40 °C (+68 to +104 °F)	Not specified
Chlorinated alkali CIP or circulation cleaners	Divo CIP VC 94	0.3 – 3.0	+20 to +60 °C (+68 to +140 °F)	Not specified
Hypochlorite-based disinfectants	Divosan Hypochlorite VT 3	0.25 – 1.0	Room temperature	Not specified
Cleaning boosters containing surfactants, oxidants	Divo Peroxy	0.2 – 0.5	+20 to +80 °C (+68 to +176 °F)	Not specified
Disinfectants containing peracetic acid	Divosan forte VT 6	0.04 – 2.0	+20 to +60 °C (+68 to +140 °F)	Not specified
Amphoteric surfactant-based disinfectants	TEGO 2000 VT 25	0.25 – 1.0	Room temperature	> 20

STORAGE TESTS

Freudenberg has carried out extensive exposure testing. The database for the CIP/SIP cleaning agents consists of over 200 compositions and 5,100 measurements. The tests were conducted using the highest recommended operational concentrations and temperatures.

EPDM

EPDM is highly resistant to acids, alkaline solutions, oxidizing media, cleaning agents and sterilization (including steam). But at higher temperatures and concentrations, EPDM swells in media containing fat and cannot therefore be used everywhere. The operational temperatures range between $-40\text{ }^{\circ}\text{C}$ to $+150\text{ }^{\circ}\text{C}$ ($-40\text{ }^{\circ}\text{F}$ to $+302\text{ }^{\circ}\text{F}$) in air and up to $+180\text{ }^{\circ}\text{C}$ ($+356\text{ }^{\circ}\text{F}$) in steam (briefly up to $+210\text{ }^{\circ}\text{C}$ ($+410\text{ }^{\circ}\text{F}$)).

HNBR

If a seal is intended to be mainly resistant to non-polar media, HNBR can be taken into consideration. Seals made of HNBR can cover a broader range of applications; however, their durability in aggressive CIP/SIP cleaning agents is lower than EPDM. HNBR should not be used in concentrated acids. Operational temperatures in air and in water reach up to $+150\text{ }^{\circ}\text{C}$ ($+302\text{ }^{\circ}\text{F}$).

VMQ

If the seal does not necessarily have to be sterilized with hot steam, silicone (VMQ) can also be used apart from HNBR. VMQ

is resistant to non-polar and polar media, but in steam it can only be used in temperatures up to $+120\text{ }^{\circ}\text{C}$ ($+248\text{ }^{\circ}\text{F}$). Its temperature range in air is from $-50\text{ }^{\circ}\text{C}$ to $+200\text{ }^{\circ}\text{C}$ ($-58\text{ }^{\circ}\text{F}$ to $+392\text{ }^{\circ}\text{F}$).

FKM

If a seal is required that can be used in non-polar media such as fat and oil up to $+180\text{ }^{\circ}\text{C}$ ($+356\text{ }^{\circ}\text{F}$) and that is also resistant to CIP/SIP media and steam, FKM should be used. FKM is also well-suited for use with citrus juices and aromatic oils. Its temperature range in air is from $-15\text{ }^{\circ}\text{C}$ to $+200\text{ }^{\circ}\text{C}$ ($+5\text{ }^{\circ}\text{F}$ to $+392\text{ }^{\circ}\text{F}$). If alkaline cleaners are in operation, FKM is not the optimal solution. In this case Fluoroprene[®] XP is the better material.

Fluoroprene[®] XP

Seals made of Fluoroprene[®] XP can also be used if EPDM is infeasible because the fat concentration is too high. This material not only shows excellent resistance to acid, alkaline solutions and steam, but also to fats and most flavoring agents. It can be used at temperatures of $-10\text{ }^{\circ}\text{C}$ to $+200\text{ }^{\circ}\text{C}$ ($+14\text{ }^{\circ}\text{F}$ to $+392\text{ }^{\circ}\text{F}$).

Simriz[®]

If the requirements are so high that none of the previously mentioned sealing materials is suitable, seals made of FFKM are used. Simriz[®] offers comprehensive media resistance in a temperature range of up to $+260\text{ }^{\circ}\text{C}$ ($+500\text{ }^{\circ}\text{F}$).

Resistance of EPDM, HNBR and VMQ

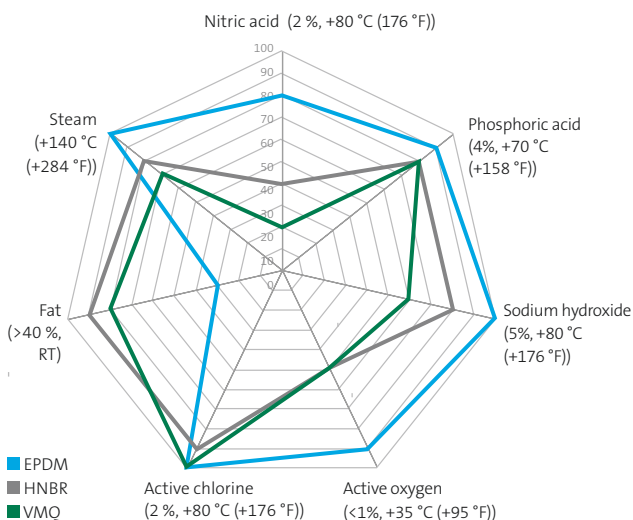

Resistance of FKM, Fluoroprene[®] XP and Simriz[®]

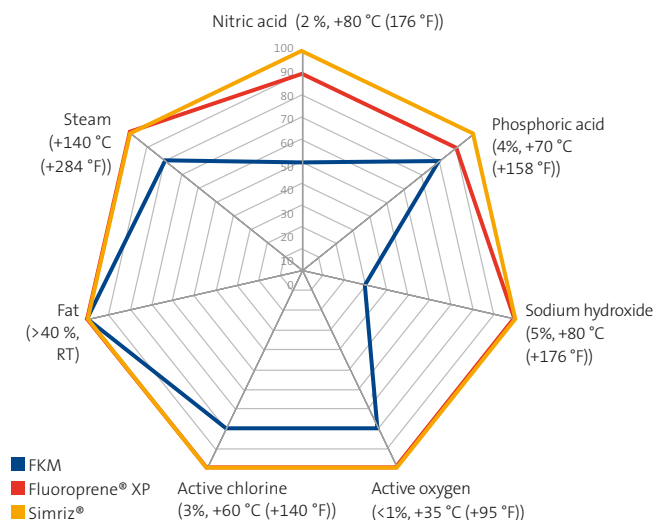



PRODUCT PORTFOLIO

O-RINGS

As a universal sealing element, the O-ring is a sealing component used in all industrial sectors. It is characterized by its excellent price-performance ratio and broad range of applications.

O-rings can be manufactured in nearly all conventional elastomer materials as a standard part in large quantities or in smaller quantities for customer-specific applications. In comparison to other sealing systems, the required installation space is extremely small, allowing material-saving designs. Though simple in form, O-rings can nonetheless be reliably used in a variety of installation configurations: as static seals in axial or radial direction, or for dynamic applications involving translatory and/or rotary movements.

Function

- Static sealing for axial and radial applications
- Dynamic sealing for applications with translatory and rotary movements

Dimensions

- Available in inch (US standard) and metric dimensions
- Numerous intermediate sizes are also available thanks to our extensive inventory of tools
- Special sizes of over 500 mm generally require new tools
- Standardized cross-section diameters from 1 mm to 6.99 mm, smaller and larger dimensions available on request

Types

- Compression- or injection-molded standard models
- Special designs and large dimensions of endless extruded cord, spliced or vulcanized
- In addition to round cross-sections, oval, rectangular, semicircular or x-shaped cross-sections are possible
- Special, customer-specific types can be created with new molding tools
- Surface-treated special designs such as non-stick and lubricated applications, painting, coating, nano-technological modification for the optimization of function and application
- PTFE casing (with separating joint) or complete FEP encapsulation for use in highly corrosive media

Possible cross-sections



Installation and assembly

- Edges should be rounded with at least $r = 0.1$ mm
- If O-rings must be stretched over sharp corners or threaded parts due to the design of the application, these surfaces should be covered with bushings/casings where possible
- In radial sealing applications, there should be lead-in chamfers on the pistons/rods (on the housing)
- When installing in pistons, avoid twisting. If necessary, use a compatible lubricant for easier assembly
- For applications in the food and beverage industry, the use of coated O-rings is recommended (e.g. PTFE lacquer, RFN treatment)
- When O-rings are installed in housings, the O-ring is compressed. Here it must be ensured that the O-ring does not warp (form a loop)
- General installation and assembly instructions, see page 94



Applications

O-rings are utilized in numerous applications and in nearly all industries. An overview of the primary applications is given below.

- Static cover seals, axial sealing
- Static piston or rod seals, radial sealing
- Dynamic seals involving translatory movement (hydraulic or pneumatic)
- Dynamic seals involving rotation
- Valve seals
- Flange seals

THE ADVANTAGES AT A GLANCE

- Can be used universally
- Available in all dimensions
- Available in all types of elastomer
- Easy to install and assemble
- Good price-performance ratio
- Small installation space

DESIGN NOTES

General	The design of O-ring sealing systems (groove, sealing surface) is described in the relevant standards (e.g. DIN 3771 and DIN ISO 3601-1)
Compression	<p>Depending on the application, the following benchmarks apply for standard cases (compression in % of the cross-section diameter):</p> <ul style="list-style-type: none"> • Static seals: 15 – 30% • Dynamic seals - hydraulic: at least 6% • Dynamic seals - pneumatic: 2 – 6%
Degree of groove fill	<ul style="list-style-type: none"> • In standard applications there is the rule that the O-ring volume is 70 – 90% of the groove volume • It should be kept in mind that the elastomer is more susceptible to thermal expansion than the metal housing • Applications in the food and beverage industry must be leak-free. The degree of groove fill can be more than 100%; specialized types of grooves should be utilized
Elongation	<ul style="list-style-type: none"> • Max. 6% in constant use • Max. 25% of the elongation at break cited in the data sheet when assembled • In the case of greater elongations, corresponding elastic recovery time should be taken into account
Compression strain	Max. 3% after installation, otherwise risk of deformation and shearing during installation
Gap widths and surfaces	<ul style="list-style-type: none"> • The acceptable gap widths and surface qualities depend on the material's hardness rating and the operational parameters. Standard values can be found in the relevant standards (e.g. DIN 3771 and DIN ISO 3601-1) • Attention: In dynamic applications involving plastic housings, the friction heat can result in localized overheating • In dynamic applications or those involving pulsating pressures, no plastics reinforced with glass fibers should be used since otherwise extensive wear will occur

ENCAPSULATED O-RINGS

Encapsulated O-rings are a combination of an elastomeric O-ring and a closed encapsulation of modified PTFE, which combine high chemical resistance and elasticity in an excellent sealing function.

They consist of an elastomer core that provides elastic contact pressure, as well as a jacket for reliable sealing in aggressive media. The core material used is either FKM or VMQ, depending on the required temperature resistance. The encapsulation is made of FEP (fluorinated ethylene propylene) or PFA (perfluoroalkoxy copolymer). Encapsulated O-rings are used exclusively for static applications, since movements or abrasive media would destroy them.

Encapsulated O-rings are basically available in all desired dimensions, internal diameters and cord thicknesses – in metric and inch sizes. Since they are only slightly expandable and compressible, the installation spaces should be designed accordingly, especially for seals with small diameters.

FEP/PFA encapsulation as well as the VMQ and FKM core are FDA-and USP-compliant as a standard. The different material types affect both the sealing properties and the price level. Thus, PTFE-encapsulated O-rings are less expensive, but must be protected against ingress of media at the seam in terms of their constructional design. Solid PTFE O-rings in contrast are extremely resistant to media but lack elasticity.

Function

- Elastomer core provides elastic contact pressure
- FEP or PFA encapsulation effectively protects the seal against aggressive media

Dimensions

- All metric and inch cross-sections are available, all standard dimensions are in stock
- FEP/PFA O-rings are available in all internal diameters with no additional tooling costs; the smallest possible internal diameter of 1.6 mm is limited by the cord thickness
- Pure PTFE O-rings are available in all dimensions, as they are manufactured by machining

TYPES	
FKM core/ FEP encapsulation	Very good compression set and permitted temperature range from –20 to +200 °C (–4 to +392 °F)
VMQ core/ FEP encapsulation	For low temperatures from –60 to +200 °C (–76 to +392 °F)
FKM core/ PFA encapsulation	For high abrasion resistance and temperatures from –20 to +200 °C (–4 to +392 °F)
FKM core/ PFA encapsulation	For high abrasion resistance and extreme temperature ranges from –60 to +260 °C (–76 to +500 °F)
VMQ hollow core	For applications in delicate devices and requiring little contact pressure

For profiles with oval, rectangular or semicircular cross-sections (all with rounded edges), please contact Freudenberg

Possible design FEP encapsulation

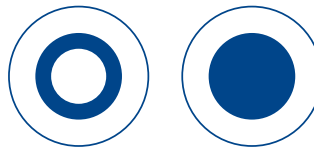

Installation and assembly

Inside sealing – grooves in housings:

- Seal must be deformed to fit in the housing
- To facilitate assembly, soak the ring in hot water for 10 minutes and then immediately fit it into the groove. To do so, push the ring's leading edge past the groove
- Carefully position the ring's trailing edge in the groove and pull back on the leading edge until the ring snaps into the groove (rod should be inserted while the ring is still warm and pliable)
- Use installation aids if necessary



Inside sealing – groove in housing

Inside sealing – groove in housing



Outside sealing – grooves on shafts:

- Use an assembly aid for installation
- Soak the ring in hot water for 10 minutes, then slide over the installation aid quickly and smoothly until the ring snaps into the groove
- If necessary, compress the ring to its original form by means of a second ring (by applying pressure)

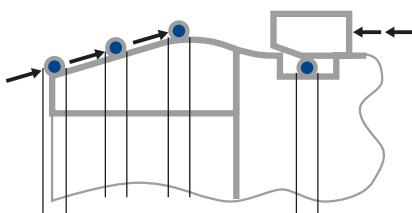

Outside sealing – grooves on shafts

Applications

FEP/PFA-encapsulated O-rings are primarily used in challenging applications:

- With aggressive media that require universal chemical resistance
- In case of high thermal stresses at high and low temperatures
- For applications in equipment in the food and beverage industry using different media and aggressive cleaning agents
- In small quantities as an economical alternative since no tools are necessary for manufacture

Dimensions

- Cross-sections from 1.6 to 25.4 mm
- Internal diameters from 10 to 600 mm
- Special dimensions available on request

THE ADVANTAGES AT A GLANCE

- Highly resistant to nearly all chemicals
- Can be used universally
- Tool-independent dimensions, many standard dimensions available in stock

DESIGN NOTES

Coarseness	No more than 50 μm on contact surfaces
Lead-in chamfers	Chamfer angle of 30° to 40°, length must be min. 50% of the cord thickness
Preparation	<ul style="list-style-type: none"> • Any parts that come into contact with the seal during assembly or in operation must be clean and free of flash • All edges must be rounded • Given the reduced elasticity and compressibility of the ring, the installation space should be axially accessible • Otherwise, extra care should be given to using clean, smooth and flash-free pins or mounting sleeves • After insertion in the groove, the ring should return to its normal dimensions

SEALS FOR PIPE CONNECTIONS



Freudenberg offers different models for static seals in standardized pipe connections used in the food, chemical and pharmaceutical industries.

These four different models are available:

- The classic seal for dairy couplings in compliance with DIN 11851
- Clamp seals in compliance with DIN 32676 and ISO 2852
- O-rings for aseptic clamp connections in compliance with DIN 11864
- Flat gaskets in compliance with DIN 28091-2 and DIN 28091-3

Seals for dairy couplings

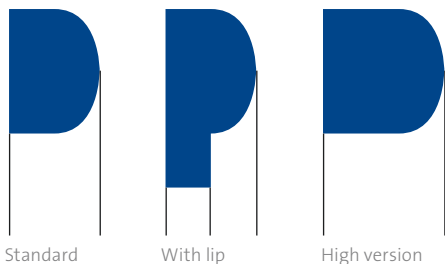

Seals for dairy couplings can be used to easily connect and seal pipe connections for liquid media. The dairy couplings standardized according to DIN 11851 are very common in the food and beverage industry. Their essential advantage is the extremely quick and easy installation thanks to their simple separation from the flange, so that they can also be frequently disassembled without difficulty. Dairy couplings are an economical solution and are particularly suitable for smaller plants not operating continuously. However, it should be taken into account that this seal component is best suited for less demanding applications. Consequently, seals for dairy couplings do not meet Hygienic Design requirements, since compression is problematic due to the lack of metallic stops, and the formation of gaps into the product area could occur. Seals for dairy couplings are available in various materials, from NBR, EPDM, FKM to VMQ and PTFE, for a maximum operating pressure of up to 40 bar.

Dimensions

- Standard form, with lip, and high version
- Standard dimensions from DN 15 to DN 100

Applications

Seals for dairy couplings cover a broad range of applications for the sealing of pipe connections:

- Suitable for use in a wide variety of pipe connections in the food, beverage and pharmaceutical industries
- Ideal for flange connections that need to be opened on a regular basis
- Used in non-critical media

THE ADVANTAGES AT A GLANCE

- Standardized sealing element
- High density of use
- Especially fast and easy assembly, regardless of the direction of installation
- Can be removed quickly
- Available in numerous approved material variants

DESIGN NOTES	
General	Adhere to the relevant standards
Surfaces	As laid out in the relevant standards, inner surfaces that come into contact with media $R \leq 0.8 \mu\text{m}$
Material	<ul style="list-style-type: none"> • FDA-compliant • Hardness between 75 and 85 IRHD • Homogeneous material • No damage during deflashing • No visible inclusions or pores allowed
Design	Preferably clamp seals with aseptic O-rings in compliance with DIN 11864
Preparation	<ul style="list-style-type: none"> • Where applicable, check pipe inclinations for cracking • Ensure proper pipe alignment during assembly

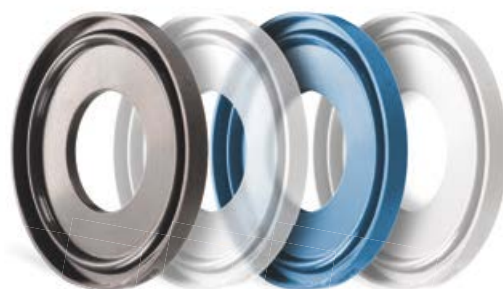

Clamp seals

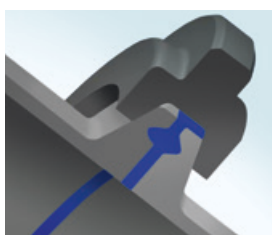

Conventional clamp seal

Clamp seals were developed for a quick and secure pipe connection for continuously operating systems. The main advantage of clamp connections is their simple installation, since the flanges are designed symmetrically and thus the seals do not need to be installed with a particular orientation. The dimensions are standardized in accordance with ISO 2852 (inch dimensions) and DIN 32676 (metric dimensions), the standardized seals are therefore particularly economical and available from stock. Since the clamp connection does not have a metallic stop, there is the danger that leakage can occur if the seal is overly compressed or not seated properly on installation.

Freudenberg offers a portfolio of four materials that can be processed into clamp seals from a single tool:

- 70 EPDM 291 (black)
- 70 EPDM 253815 (white)
- 75 Fluoroprene® XP 41 (blue)
- 70 VMQ 117055 (transparent)

Applications

Clamp seals cover a broad range of applications for the sealing of pipe connections:

- Suitable for use in a wide variety of pipe connections in the food, beverage and pharmaceutical industries
- Ideal for flange connections that need to be opened on a regular basis
- Used in non-critical media

Dimensions

- According to ISO 2852
- Nominal dimensions from DN 10.2 to DN 219.1
- According to DIN 32676
- Nominal dimensions from DN 6 to DN 200
- Nominal dimensions from 1/4" to 6"

THE ADVANTAGES AT A GLANCE

- Standardized sealing element
- High density of use
- Especially fast and easy assembly, regardless of the direction of installation
- Can be removed quickly
- Available in numerous approved materials variants

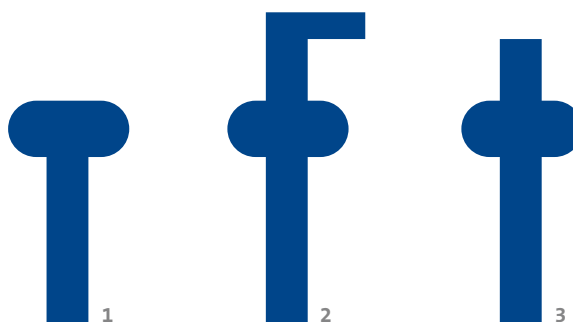

- 1 Clamp connection with nominal diameter DN 6 to DN/OD ¾"
Series A: DN 6 to DN 8
Series B: DN/OD 10.2 to DN/OD 17.2
Series C: DN/OD ¼" to DN/OD ¾"
- 2 Clamp connection with nominal diameter DN 10 to DN/OD 6"
Series A: DN 10 to DN 200
Series B: DN/OD 21.3 to DN/OD 219.1
Series C: DN/OD 1" to DN/OD 6"
- 3 A version with truncated lip pursuant to ISO 2852 is also available



O-rings for aseptic clamp connections

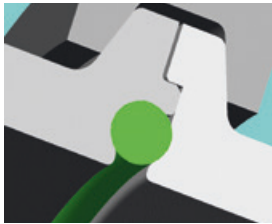

Aseptic clamp seal

In order to ensure that Hygienic Design requirements are met, clamp seals with aseptic O-rings compliant with DIN 11864 were developed. They optimally combine the advantages of easy installation and a sealing area free of dead space. Aseptic O-rings are available in stock in specialized high-performance materials with various approvals.

Dimensions

- Series A: nominal dimensions from DN 10 to DN 100
- Series B: nominal dimensions from DN 13.5 to DN 114.3
- Series C: nominal dimensions from 1/2" to 4"

Flat gaskets

Another option to seal a pipe joint is a flat gasket. It is inserted between two flat flanges, which are connected to each other by screws. With the help of such flanges, different system elements, such as valves, fittings, pipelines, pumps etc. are added together. The sealing material should offset and seal the macro unevenness of the flanges well, on the one hand, and be resistant to the media flowing in the pipes on the other. An almost inert material is needed both in the food (e.g. detergent concentrates) as well as in the pharmaceutical and chemical industries (aggressive solvents and chemicals). Freudenberg offers a range of flat gasket materials with excellent chemical resistance to suit any application. Flat gaskets primarily provide the static sealing of two sealing surfaces.

A flat gasket, on which a compacting pressure greater than the internal pressure is applied, is used to create a secure seal. Freudenberg's flat gasket portfolio covers all these requirements and also enjoys market-specific approvals. There is a choice of gaskets of the following three material classes according to DIN 28091.

NAME	PANEL FORMAT IN MM	THICKNESS IN MM
FG-120	1,500 x 1,500	0.5
		0.8
	2,000 x 1,500	1.0
		1.5
		2.0
FG-180	1,200 x 1,200	3.0
		1.0
	1,500 x 1,500	1.5
		2.0
		3.0
FG-360	1,500 x 1,500	0.5
		1.5
		3.0
		6.0



FG-120 – FG-120 is a fiber-reinforced graphite seal in an unmistakable royal blue color. This flat gasket is reinforced with aramid fibers (bound with NBR) and thus withstands a wide variety of chemical and thermal stresses.

FG-180 – FG-180 is a silica-filled flat gasket made of modified PTFE. Its very good mechanical characteristics, thermal resistance and white color make it a particular favorite of the pharmaceutical industry.

FG-360 – The unique flexibility of FG-360 is due to the fact that it consists of 100% expanded PTFE (ePTFE). Gaskets made from expanded PTFE stand out for their high temperature cycle resistance. They also resist cold flow and are considered especially pure.

In addition to the conventional flat gasket form made of FG-360, Freudenberg also offers a sealing band (joint sealant). This sealing band, delivered in rolls, can be individually cut and is self-adhesive on one side. That means it can seal joints, covers or frames quickly and reliably – without tooling costs. The FG-360 joint sealant is 25 m long and is available in a variety of widths.

CHARACTERISTICS	FG-120	FG-180	FG-360	
			1.5 MM THICK	3.0 MM THICK
Type	FA-A1-0 DIN 28091-2	TF-M-0 DIN 28091-3	TF-0-0 DIN 28091-3	TF-0-0 DIN 28091-3
Material	Graphite, aramid fibers (bound with NBR)	Silica-filled PTFE	Expanded PTFE	Expanded PTFE
Color	blue	white	white	white
Approvals	<ul style="list-style-type: none"> • EU Reg. 1935/2004 • TA Luft • DVGW • KTW • WRAS • W 270 	<ul style="list-style-type: none"> • EU Reg. 1935/2004 • FDA 21 CFR 177.1550 • TA Luft • DVGW 	<ul style="list-style-type: none"> • FDA 21 CFR 177.1550 • USP Class VI –121 °C (250 °F) • TA Luft 	<ul style="list-style-type: none"> • FDA 21 CFR 177.1550 • USP Class VI –121 °C (250 °F) • TA Luft
Density g/cm ³	1.74	2.10	0.85	0.85
Tensile strength longitudinal N/mm ²	18.0	17.0	14.0	18.0
Compression %	6.0	5.0	69.0	66.2
Recovery %	60.0	45.0	7.6	11.6
Temperature range	–100 to +300 °C (–148 to +572 °F)	–200 to +210 °C (–328 to +410 °F)	–268 to +315 °C (–450 to +599 °F)	–268 to +315 °C (–450 to +599 °F)

DIAPHRAGMS



Diaphragms form a reliable but flexible separating wall between two component spaces. The volume changes of the separated media can be converted into force.

Diaphragms are especially interesting sealing components for the food and beverage industry where they can perform a number of different functions. Available in all basic elastomer variants, or with application-specific modifications such as fabric reinforcements, metal inserts or foil layers, diaphragms are extremely dependable and resistant to media. They are very affordable solutions, as the minimal requirements with regard to tolerances and surface qualities of the surrounding components make it possible to produce them inexpensively.

Function

- Regulation and switching using pressure that is converted into rod force
- Separation of media in component spaces with nearly identical pressure levels
- Pumping and compression of liquids and gases
- Measuring volume flows
- Actuation of valves

Dimensions

From 5 mm to maximum diameter of 1,000 mm (or larger for individualized applications).

Installation and assembly

Please refer to page 94 for general assembly and installation instructions.

Applications

Since diaphragms can be very closely tailored to specific applications in terms of their shape and materials composition, they can be used in a very broad spectrum of applications. Typical areas are:

- Actuators
- Fittings
- Water reservoirs
- Pumps and compressors
- Valves and controllers

THE ADVANTAGES AT A GLANCE

- Good media resistance
- Broad range of functions and applications
- Economical
- Highly dependable

TYPES	
Diaphragm types	<ul style="list-style-type: none"> • Flat diaphragms • Convoluted diaphragms • Plate-shaped diaphragms • Rolling diaphragms • Individual designs available upon request
Materials composition	<ul style="list-style-type: none"> • MB as pure rubber diaphragm • GMB with fabric insert or overlay • MBM with metal insert and/or film • GMBM with metal insert and fabric overlay or insert and/or film • Diaphragms with film overlay made of PTFE, modified PTFE, electrically conductive foils etc. • Diaphragms made of pure PTFE
DESIGN NOTES	
Design	<ul style="list-style-type: none"> • In designing diaphragms, it is advisable to use FEM calculations to reduce development and testing times • The diaphragm's construction position (0 position) should be selected such that the diaphragm is not under load • The deflection of the diaphragm during operation should be designed in such a way that no overstretching and no excessive stress peaks can occur • The diaphragm's mountings must in some cases be able to withstand considerable forces and should be designed accordingly. It is advisable to utilize FEM calculations here, too
Choice of materials	<ul style="list-style-type: none"> • The elastomer base material, as well as any applicable fabric, metal or plastic inserts, must be resistant to all media involved in operation • For applications in particularly aggressive media, it is advisable to add a layer of PTFE to the diaphragm

HYGIENIC USIT RINGS



Freudenberg's Hygienic Usit® is a product developed specifically for the requirements of the process industry which sets standards in purity.

Since it was in the past not possible to implement hygienic screw fittings, machine manufacturers and operators resorted to welding solutions. However, welded connections cannot be separated again easily. Still other system manufacturers often employ conventional, non EHEDG-compliant fittings in or on the product space. This carries the risk that product residues accumulate under the screw head and become a source of contamination. The tightening of the screw already holds numerous sources of error, e.g. damage to the surface of conventional screws by the mounting tool.

Freudenberg's Hygienic Usit® offers the possibility to realize hygienic screw connections. Thanks to the cooperation with the company NovoNox, the washers can be purchased with hygienic screws and cap nuts. The connection is available in the dimensions M4, M5, M6, M8, M10, M12 and M16. Additionally we offer bolts and cap nuts in M3 designed for the M4 washer. Also in combination with a standard hexagon screw with flange according to DIN EN 1665, the Hygienic Usit® prevents the formation of bacteria. In open processes, where corrosion is an issue due to the wet environment, the Hygienic Usit® minimizes the risk of corrosion because of the prevention of bacteria. But the surface properties of the standard screws are not compliant to Hygienic Design standards. For this reason they are not recommended for applications with direct product contact.

The screws and cap nuts with collar from NovoNox conform to 3-A® Sanitary Standards, are polished to a high shine and achieve a roughness depth of up to max. $R_a = 0.04 \mu\text{m}$, thanks to special manufacturing processes. The unique surface finish is free of flash and dimples which would preclude a hygienic design. Furthermore, NovoNox has patented special sockets with protective plastic inserts that do not damage the screws when tightening.

Applications

- In closed process steps for areas in contact with the product
- In open processes, to ensure the complete exterior cleaning and steam sterilization of the plant

Compounds

The elastomer bead of the standard Hygienic Usit® is made from three EPDM variants. They are all suited for direct contact with food and pharmaceuticals and are resistant against CIP/SIP media. The black EPDM 291 ist the standard compound for the process industry. The white EPDM 253815 is especially interesting for the pharmaceutical industry, while the blue EPDM 217676 is used as a variant in color. For applications with aggressive media or high temperatures, we offer the Hygienic Usit® made from our fluorinated Fluoroprene® XP 41 material (on request). This blue universal material also minimizes flavor transfer.

THE ADVANTAGES AT A GLANCE

- EHEDG- and 3-A® Sanitary Standards-certified
- Optimally matched screw-cap nut-Usit composite
- Prevention of contamination due to dead space-free design
- Cleaning with CIP, SIP, WIP, COP, OPC and WOP process possible



NovoNox cap nut

Material: 1.4404 in A4-70 quality
Highly polished with up to max. $R_a < 0.04 \mu\text{m}$



Freudenberg washer

Material: Elastomer made of 70 EPDM 291, 70 EPDM 253815, 70 EPDM 217676 or Fluoroprene® XP 41 (on request)
Shim of 1.4404



NovoNox hexagon head screw with collar





Material: 1.4404 in A4-70 quality
Highly polished with up to max. $R_a < 0.04 \mu\text{m}$

ROTARY SHAFT SEALS

Only Freudenberg offers the original Simmerring® as a rotary shaft seal for the sealing of rotary shafts and spindles and the protection of bearings. This sealing system is primarily intended for use in applications involving rotary motion.

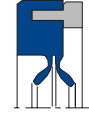
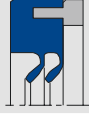
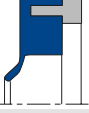
Simmerring® Radiamatic® HTS II rotary shaft seals are a custom-developed product made of PTFE and can be used in a broad spectrum of food and beverage industry applications. The product stands out because of its low friction, a result of PTFE's own low coefficient of friction, in conjunction with the low contact pressure exerted on the rotary shaft by the lip. The primary advantage of HTS II rotary shaft seals is their high media resistance, since the media to be sealed come into contact exclusively with PTFE.

PTFE is a material that performs exceptionally well in nearly all media and cleaning agents and makes especially hygienic processes in food and beverage production possible. HTS II rotary shaft seals also offer outstanding sealing performance with minimal contact pressure, which is generated by the geometry of the sealing lip joint and the memory effect of the PTFE. This concept minimizes abrasion while simultaneously ensuring a reliable sealing performance. Special variants are also available for more extreme demands, e.g. higher pressures, dead space-free design, or dusty operating conditions. Lastly, the seal's innovative lip design also makes it possible to affordably reduce the number of components needed for individual applications.

TYPES		
HTS II 9535	With standard lip for conventional applications	
HTS II 9536 SL	With additional dust lip for use in dirty and dusty environments that pose a risk of foreign objects getting under the sealing lip and in applications involving alternating pressure-vacuum operation	
HTS II 9538 DL	With a double sealing lip for high security standards	
HTS II 9539 VL	Dead space-free version with protruding sealing lip for Hygienic Design applications	
WADB 9461	<ul style="list-style-type: none"> Extremely compact shaft seal for tight installation spaces To be used only in combination with a secondary seal made of FKM or virgin PTFE on the surface that will come into contact with media 	
HTS II 9541 with twist	With dynamic return capability for applications with high liquid level or increased demands on impermeability	
HTS II EWS	<ul style="list-style-type: none"> For use at elevated levels of shaft runout With integrated flexible bellows element Application limits up to 1 m/s and 3 bar 	



Function

- Dynamic sealing for applications involving rotary motion
- Sealing pressure is generated by the special lip design and PTFE's memory effect

Dimensions

- Manufactured by machining independent of molds, therefore no limits on any dimension
- Standard dimensions from 10 to 125 mm shaft diameter available in stock
- Smaller or larger dimensions available upon request

Installation and assembly

- Must always be assembled as a combination of sealing ring and retaining ring
- If seal is disassembled, the clamping ring must be replaced since it is deformed by the pressing operation
- If possible, use pressing tools with built-in stops to avoid excessive axial compression and the risk of damaging the seal
- To aid assembly, the rotary shaft seal can be lightly oiled if desired
- If possible, disassemble the sealing ring from the inside using a shaft sleeve; alternatively, a bearing remover can be used, provided there is sufficient room. If the seal is damaged, replace the sealing ring
- Please refer to page 94 for general installation and assembly instructions

Applications

Due to their variable designs, the HTS II rotary shaft seals offer an enormous application range for production processes involving the sealing of media, the separation of lubricants and media and the secure sealing of cleaning processes.

Suitable for use in

- Beverage filling facilities
- Food and beverage production machinery
- Process equipment used in pharmaceutical and cosmetics manufacturing
- Mixers and separators
- Machines with a high rotational speed
- Cleaning and sterilization processes
- The reliable sealing of dangerous substances and highly valuable production media

THE ADVANTAGES AT A GLANCE

- Variable and reliable use in the food and beverage industry
- Highly resistant to media and temperatures
- Dead space-free variants available for hygienic applications
- Minimal abrasion
- Available in all dimensions
- Economical to use, as they make secondary seals unnecessary

DESIGN NOTES

General

- HTS II rotary shaft seals must be installed as a unit consisting of a PTFE sealing ring and a stainless steel retaining ring
- The retaining ring is deformed during installation and cannot therefore be reused
- The installation space must be axially accessible
- Lead-in chamfers on both the shaft and housing should be included to prevent ring damage

Surfaces	Peak-to-valley heights	R_a	R_t
	Housing	<1.8 μm	<10 μm
	Shaft, twist-free	0.1 to 0.2 μm	0.5 to 1.0 μm
	Hardness of running surface	45 to 65 HRC	

V-SEAL SET PACKINGS

V-Seal set packings are multi-part sealing sets primarily used in applications involving translatory motion. As they offer lower friction and require less pre-tensioning forces, they represent a worthwhile alternative to U-packings.

V-Seal set packings normally consist of a compression ring, several V-shaped packing rings and a backup ring, providing reliable sealing for spindles on regulating and shut-off valves, rods on plunger pumps, hydraulic cylinders as well as swivel joints and mixers. Predominantly used with translatory motion but also with slow rotation, they generate less friction and require considerably less initial axial pretensioning force than stuffing box packings, for instance.

As the standard materials for V-Seal set packings are PTFE and PTFE-carbon compounds, they can be manufactured by machining from semifinished products in a particularly economical manner without the use of tools. Special-purpose V-Seal set packings made of PTFE-impregnated Nomex fabric require tools, but are also better suited for higher pressures, as they are less susceptible to cold flow. Freudenberg has a broad range of suitable tools in its inventory for this.

Further materials such as polyethylene, PEEK and Univerdit (a compound of PTFE and graphite) are also available on request, as are specialized profiles, should none of the three standard options be compatible with the individual application.

Function

- Multi-part sealing set consisting of a compression ring, V-packing rings and a backup ring
- Predominantly used with translatory motion, or occasionally with slower axial motion

Dimensions

Virgin PTFE and PTFE compounds:

- Available in all inventory-standard dimensions
- Special customer-specific dimensions are possible without difficulty

PTFE fabric:

- Extensive inventory of tools available
- Special customer-specific dimensions available upon request

Installation and assembly

Please refer to page 94 for general installation and assembly instructions.

Primary applications

- Regulation and shut-off valves
- Dosing systems
- Mixers
- Pivot joints

Predominantly used to seal

- Spindles of control and regulation valves
- Rods (translatory motion, possibly in combination with minor rotation)
- Low-speed shafts

TYPES	
PTFE	<ul style="list-style-type: none"> • DM 9403: stable profile for static sealing and pulsating pressures up to 300 bar • DM 9406: relatively rigid lip profile for dynamic sealing and pressures up to 200 bar • DM 9409: flexible lip profile for dynamic sealing and pressures up to 50 bar as well as vacuum
PTFE-fabric form-pressed	<ul style="list-style-type: none"> • Packing rings made of PTFE-impregnated fabric • For certain applications packing ring combination of PTFE-impregnated fabric and virgin PTFE/PTFE compound for pressures up to 700 bar with low friction

THE ADVANTAGES AT A GLANCE

- Highly variable to cover a broad range of applications
- High pressure resistance (virgin PTFE and PTFE compounds up to 30 MPa, fabric-reinforced V-packing rings up to 70 MPa)
- Very good temperature resistance (–200 °C to +260 °C (–328 °F to +500 °F))
- No tooling costs for virgin PTFE/PTFE compound variants
- Adjustable set heights
- Low friction
- Universal chemical resistance
- Low susceptibility to cold flow and extrusion in PTFE-fabric variant



Composition and installation

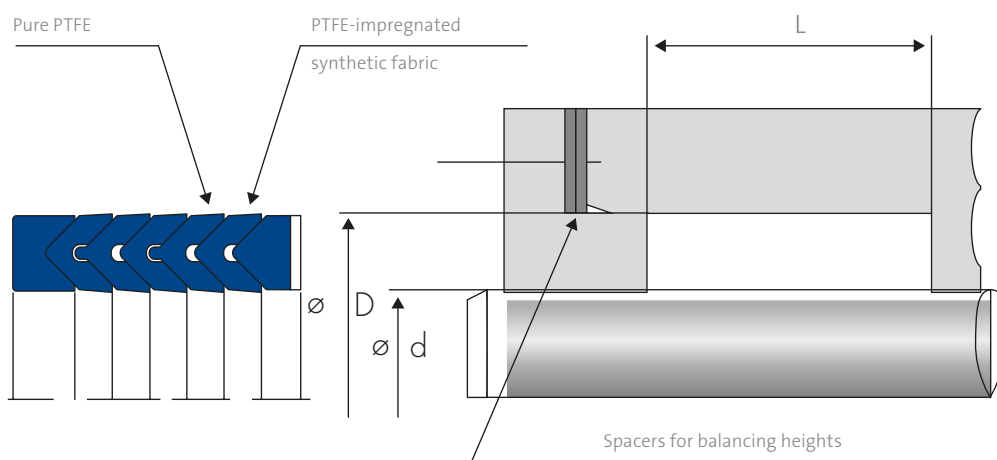

DESIGN NOTES

Virgin PTFE/ PTFE compound V-Seal set packings	<ul style="list-style-type: none"> • Due to their lack of elasticity and high degree of thermal expansion, V-Seal set packings must be preloaded using a spring device • The spring force should be tailored to the seal's design, dimensions and operating conditions. The higher the spring force, the less leakage. The parameters can be requested from Freudenberg • When using a spring device for installation on the side turned away from the pressure, set the spring force to maximum pressure • For information on permissible installation space tolerances and the characteristics of their surfaces, please consult Freudenberg
PTFE/fabric V-Seal set packings	<ul style="list-style-type: none"> • Can usually be installed without spring pre-load • Installation space must be adjustable (see diagram) • Tolerances and surface characteristics match those of the virgin PTFE/PTFE compound variant
General	In the standard version, V-Seal set packings consist of a compression ring, a backup ring, and three V-packing rings
Special installation notes	In order to avoid damaging the seal during installation, the installation space and rods and/or shafts should include lead-in chamfers

STUFFING BOX PACKINGS

From centrifugal and piston pumps to applications on spindles and valves – stuffing box packings are a type of seal broadly used throughout the food and beverage industry where sealing is achieved by compressing the packing.

The functional principle of a stuffing box packing consists in the axial compression of endless woven cords pressed into rings. This process generates a radial compression on the sealing location, which must be greater than the internal pressure to ensure reliable sealing. Using different types of stranding and packing materials to match the respective chemical and thermal requirements, stuffing box packings can be tailored to a variety of application scenarios. In addition to the classic woven packings, Freudenberg also offers the special Valtec variant, made of a non-woven material impregnated with PTFE which is wound and compressed into rings.

Pressures play an important role in the sealing function. When there is no pressure on the packing, a good compression set is necessary to maintain a good seal using resilience. Stuffing box packings are self-amplifying under pressure: their maximum pressure load is influenced by the gap width. To improve their gliding ability and therefore the cross-section impermeability, stuffing box packings are also impregnated with lubricants.

Types of stranding

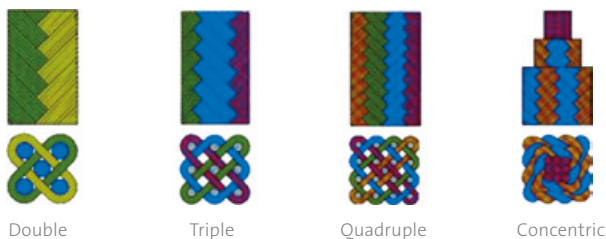

Function

- Sealing in pressure-free environments by means of restoring force
- Self-amplifying sealing function under pressure (the higher the pressure, the better the sealing)

Dimensions and types

- Double, triple and quadruple diagonally braided, with quadratic cross-section from 3 mm to 25 mm, available by the meter
- Tube-braided packings, also available as double-layer bands
- Braided packings as pre-cut components or pressed in ring form
- Graphite versions as pre-pressed rings and bushings
- PTFE-impregnated packings (Valtec) as rings or bushings
- Combination of different packing rings to a set, e.g. with anti-extrusion versions on the outside and low-friction rings on the inside
- Use of “lantern rings” for lubrication, shut-off or cooling
- Versions with internal or external springs for plunger pumps
- Grafiflex as cover seals in internal pressure-supported systems

DESIGN NOTES	
Packing cross-sections	<ul style="list-style-type: none"> • For centrifugal pumps, plunger pumps and mixers: $s = 1.4 \times \frac{1}{2} d$ (d = shaft diameter in mm) • For valves: $s = 1.2 \times \frac{1}{2} d$ (d = spindle diameter in mm)
Surfaces	<ul style="list-style-type: none"> • Surface roughness for shafts, spindles, and valves: $R_a < 0.25 \mu\text{m}$ • Surface roughness for housings: $R_a < 0.25 \mu\text{m}$
Spindle hardness	Min. 40 HRC, for heavier loads 60 HRC
Amount of guide play in the spindle	Less than $\frac{1}{1,000}$ of the spindle diameter
Gap widths	<ul style="list-style-type: none"> • Max. permissible gap between spindle and gland packings/housing bore = $\frac{2}{100}$ of the packing width • For larger widths use packings with high-strength aramid yarns
Radial shaft deflection	Max. 0.001 x the shaft diameter



Recommended number of rings for valves

MEDIA PRESSURE (BAR)	RECOMMENDED NUMBER OF RINGS
<10	3
10 – 30	4
30 – 60	5
60 – 100	6
100 – 250	7
250 – 500	8

Recommended number of rings for centrifugal pumps and mixers

MEDIA PRESSURE (BAR)	RECOMMENDED NUMBER OF RINGS
<5	3
5 – 10	4
10 – 20	5
20 – 30	6
>30	7

Recommended number of rings for plungers

MEDIA PRESSURE (BAR)	RECOMMENDED NUMBER OF RINGS	
	WITHOUT SPRING PRELOADING	WITH SPRING PRELOADING
10	3	2
16	3 – 4	2 – 3
25	4	2 – 3
40	4 – 5	3
64	5	3 – 4
100	5 – 6	3 – 4
160	6	4
250	6 – 7	4
400	7	4 – 5
630	7 – 8	4 – 5
1,000	8	5

Installation and assembly

- Installation space must be axially accessible
- Ensure that the gland packing goes far enough into the stuffing box and check the reset path
- Use a cutting gauge when cutting the material
- Form-pressed rings should be opened axially, then slightly flexed radially and laid over the shaft, cut end first. Next, press the sleeve completely into the installation space and tighten it according to the component specifications
- Please refer to page 94 for general installation and assembly instructions

Applications

- Valves
- Mixers
- Homogenizers
- Piston and plunger pumps
- Fittings

Stuffing box design

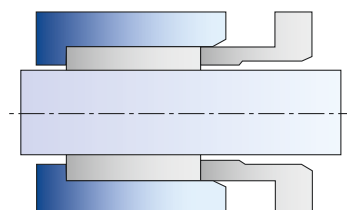

THE ADVANTAGES AT A GLANCE

- Broad variety of applications
- Ideal for higher pressures up to 1,000 bar (in special cases up to 3,000 bar)
- Broad temperature range from $-200\text{ }^{\circ}\text{C}$ to $+550\text{ }^{\circ}\text{C}$ ($-328\text{ }^{\circ}\text{F}$ to $+1,022\text{ }^{\circ}\text{F}$) as graphite variant up to $+700\text{ }^{\circ}\text{C}$ ($+1,292\text{ }^{\circ}\text{F}$)
- High media resistance
- Numerous economical standard dimensions
- Simple assembly
- Special solutions in compliance with TA Luft
- FDA-compliant materials

PRECISION MOLDED PARTS

Molded parts are components that cannot be assigned to a standardized group in terms of their geometries and applications; instead, they are designed for specific sealing applications.

In complex applications, it is often difficult if not impossible to use standard components to ensure an optimal sealing function. In such cases, molded parts are designed to precisely match the application in question – the molded part becomes a customer-specific solution. This can be accomplished by modifying a standard component, for example an O-ring, or by designing the materials and geometry for an entirely individualized molded seal. Typical molded seals in the food and beverage industry include butterfly valve seals and U-packings, as well as impellers for pumps. Another typical example for molded parts is a pig. Pigs secure a residue-free cleaning process and an efficient use of products. Freudenberg offers pigs made from highly resistant low-friction-elastomers like EPDM and Fluoroprene® XP.

The use of a molded seal is preceded by a comprehensive development process, in which the customer is usually closely involved. Not infrequently, Freudenberg is also already involved at the start in a machine or component development in order to ensure high system reliability from the outset with specially matched sealing solutions.

Function

Various sealing functions, depending on the requirement and component, such as:

- Pressure-free sealing through the use of restoring force
- Self-amplifying sealing function under pressure
- Reduction of incoming pressure
- Sealing against media permeation

Dimensions

Vary widely depending on the design and application, from only a few millimeters up to one meter.

Types

- Elastomer composites in material combinations with metals, ceramics or plastics
- Precision molded parts
- Elastomer bellows
- Extruded profile sections

Design notes

When developing molded seals, the user and the seal manufacturer should work together intensively from the outset in order to avoid unnecessary steps and to keep the development time as short as possible. So as to preclude the need for multiple revisions, new versions and repeated testing in the development process, Freudenberg can use FEM analysis prior to construction of the sample mold in order to determine potential strains on and deformations of the molded seal, taking into account the temperature and swelling.

Installation and assembly

Please refer to page 94 for general installation and assembly instructions.



Applications

- Filling head seals and valve seats for beverage systems
- Molded seals for double seat valves and sterile valves
- Profile gaskets for separators
- Frame gaskets for filters
- Joining technology (fittings)

THE ADVANTAGES AT A GLANCE

- Global leader in sealing expertise
- Focused industry-specific and application-specific know-how
- Extensive materials and manufacturing expertise
- Reliable quality management
- Extensive testing facilities for dependable prognoses
- Innovative simulation and analysis methods

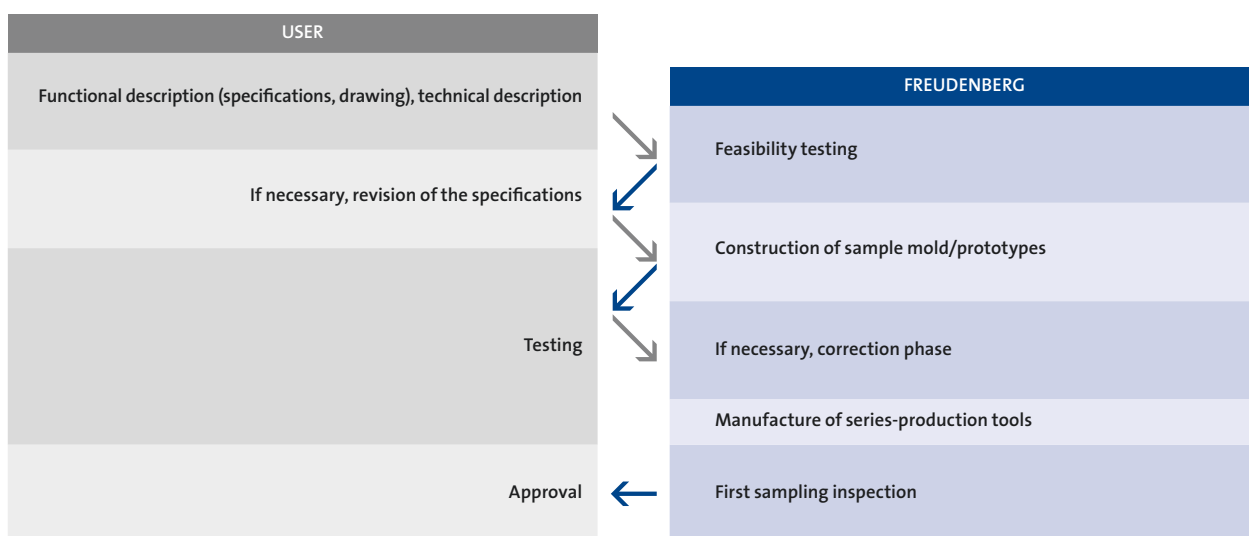

BUTTERFLY VALVE SEALS

Seals for butterfly valves ensure the reliable function of butterfly and disc valves. In the food and beverage industry, they are used wherever a shut-off valve is sufficient and a more extensive flow regulation is not necessary.

Shut-off butterflies, butterfly or disc valves are normally four-part units composed of a two-part housing with a threaded connector, weld-on ends or a clamp connector; a valve disc and a butterfly valve seal. It is only the last component that guarantees the integrity of the entire unit, making it indispensable in preventing all three types of potential leakage – at the pipe seal, the flange and the actuator.

Despite the simplicity of their basic design, seals for butterfly valves are expected to master extremely demanding operating conditions: when the valve is open, the gasket should only minimally reduce the pipe diameter, and must be nearly free of dead space. The valve should be easy to close, but at the same time exhibit high compression when closed to provide a perfect seal. Optimum materials, torque-reducing geometries, and highly realistic testing are needed in order to combine all of the desired qualities.

The requirements are further intensified by the high flow speed when the valve is closing. This flow creates a major pressure differential and pressure fluctuations, both of which can blow the seal out of its seat into the pipe. In order to optimally tailor the seal design to prevent this, Freudenberg utilizes efficient and highly-effective computational models such as FEM.

Dimensions

- Dimensions fit standard DIN and ISO pipe dimensions
- Standard metric: DN 15 to DN 250
- Standard inch: 1" to 6"
- Individual dimensions available on request

Types

- Customer-specific types available on request thanks to FEM calculations
- Special models with additional treatment (e.g. RFN)

Installation and assembly

- When stretching the gasket over the valve, avoid ledges, sharp edges and threaded surfaces on the shafts
- Please refer to page 94 for general installation and assembly instructions

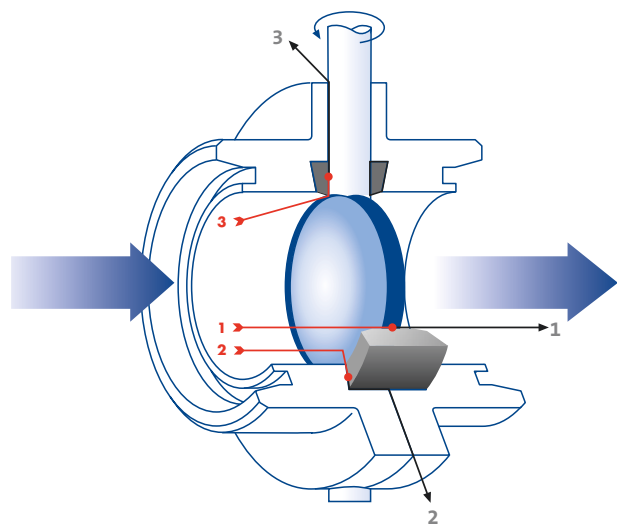

- 1 Optimal compression on the butterfly valve (or "valve disc") ensures that the sealing location is reliably sealed. Here the goal is an ideal compromise between the integrity of the closed valve and the torque involved in actuating it
- 2 The quasi-static sealing location is also worth examining. If the compression is oriented correctly, the leakage of production and cleaning media is reliably prevented
- 3 The axle lead-through represents a particularly difficult sealing location. The optimal design dependably prevents leaks



Applications

- **Beverage industry:**
 - Use of EPDM materials
 - Thermal resistance in steam and sterilization to +140 °C (+284 °F), for brief periods up to +160 °C (+320 °F)
 - Suitable for aqueous media and cleaning processes
 - For applications involving nitric or formic acid, high temperatures and media concentrations, EPDM represents the most economical solution in comparison to other materials. In extreme cases, however, EPDM is not optimal either and alternatives may have to be used
- **Dairy industry:**
 - EPDM, FKM, VMQ or HNBR materials are used, depending on the fat content and temperature
 - In certain cleaning media, HNBR, FKM and VMQ cannot match the service life of EPDM; however, unlike EPDM they are resistant to fats, thus making them well-suited for use at high temperatures and concentrations
- **Pharmaceutical and chemical industry:**
 - EPDM, FKM, VMQ or HNBR materials are used, depending on the production media and solvents
 - FKM is resistant to certain oils and some aromatic oils, but shows limited resistance to alkaline cleaning media. It is also more prone to swelling in acids, making it necessary to select compatible cleaning media when using FKM
 - Certain applications in the production of flavorings, in pharmaceutical and chemical processes exceed the resistance properties of EPDM, VMQ, and HNBR. In such cases, Freudenberg recommends the use of Fluoroprene® XP materials

THE ADVANTAGES AT A GLANCE

- Patented torque-reducing design allows high-frequency operating cycles with low actuating forces and minimal abrasion
- Extremely easy to assemble
- Leak-free and dead space-free variants available
- Low-friction coatings available
- A broad range of material versions for high media and temperature resistance

DESIGN NOTES	
Dimensions	<ul style="list-style-type: none"> • Information on the minimum and maximum dimensions of the flanges and valves are necessary for gasket design • Minimum necessary and maximum permissible actuating forces should be included in design considerations • Use of a patented Freudenberg design to reduce torque
Tolerances	Lowest possible tolerances with regard to the seal and installation space
Surfaces	<ul style="list-style-type: none"> • Perfectly smooth (no gaps or seams) in the dynamic area • The sealing butterfly should be polished on the sealing surface (R_{max} 2.5 μm, R_a 0.05 – 0.3 μm) • The shaft should be polished in the sealing area (R_{max} 2.5 μm, R_a 0.05 – 0.3 μm)

LOW PRESSURE PROFILES



Large areas are difficult to seal with commonly made products because tools are too expensive or unfeasible to realize. With the help of low pressure profiles, it is possible to seal these difficult points.

Profiles and cords

Typical examples are oven door seals. For the standard program, there is a variety of different tools for different materials available. By switching from mold-based to low pressure parts, tool costs can be saved when developing customized individual applications.

Freudenberg has developed a special vulcanization process in which the cord and the joint are made of the same material. Thus, a uniform quality of the seal is achieved. In conventional low pressure gaskets of other manufacturers, the joint is often connected by means of an adhesive, resulting in a significant difference in quality. In contrast to the seals made by Freudenberg, the joint here is not reliably resistant to thermal influences and process media or to cleaning agents and steam sterilization.

Freudenberg offers low pressure profiles and rings in the following elastomers:

- 70 EPDM 391: resistant to water, steam, acid and alkali solution
- 70 EPDM 471: resistant to disinfectants and CIP/SIP media
- 75 Fluoroprene® XP 41: resistant to steam, fat and CIP/SIP media
- 80 NBR 217383: good low temperature flexibility and abrasion resistance

Inflatable seals

Wherever the containers and doors of systems must be protected against germs and dirt, the gap bridgings are sealed with inflatable profiles. In laboratories and research institutes, the standard silicone material often creates problems due to insufficient stability. Also, the profiles of conventional inflatable seals often stick to the door frame and make it difficult to open the door, which in turn damages the seal.

To produce a seal that is fully closed around the entire door frame, the two ends of the profile are butt joint-vulcanized. The molecules cross-link at the joint to the same material as the profile. Consequently, the profile at the joint seals as reliably as at all other points. The FDA-compliant material 70 EPDM 471 is ideal for use under aggressive sterilization and cleaning conditions. Thanks to its high abrasion resistance, long service lives can be achieved. During the cleaning process, the gasket is inflated, resulting in high contact stress preventing leakage. After cleaning, the seal is relaxed again and the door opens without damaging the seal. Freudenberg offers inflatable seals on request even with a specific valve matched to the seal that controls the supply of compressed air. Instead of a threaded coupling, this valve works by means of a click mechanism, making it easier to install.

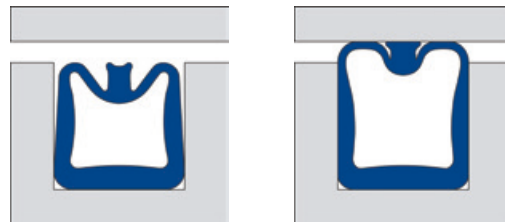

Evacuated state

Seal under pressure

THE ADVANTAGES AT A GLANCE

- Seals reliably against external influences
- Easy opening and closing of doors, for example
- Long service life
- Very good chemical and thermal resistance
- Seal and valve are perfectly matched
- Individual dimensions by means of butt joint-vulcanization

GUIDE STRIPS



Guide strips are used in various machines for the food and beverage industry to compensate for the lateral forces and deflections occurring.

This requires a high pressure resistance of the material. At the same time, the material used must have sufficient flexibility to prevent it from being damaged during assembly. In food and beverage applications where guide strips have direct contact with the medium, the materials used must comply with the legal framework. Comparable combinations of approved materials demonstrated in a benchmark that they do not withstand the high forces, e.g. in homogenizers, and have a propensity to gap extrusion. This leads to increased wear and thus to a significantly reduced service life. Guide strips made of PTFE Y005 ensure low wear and a much longer durability thanks to minimized extrusion propensity. PTFE Y005 is a special compound and consists of a virgin, high-grade pure PTFE and a filler.

THE ADVANTAGES AT A GLANCE

- High compressive strength with simultaneous flexibility
- Resistant to CIP/SIP cleaning media
- Low extrusion propensity
- Low wear ensures a long service life
- Different sizes up to 200 mm available at short notice
- Food-grade materials

Extrusion length

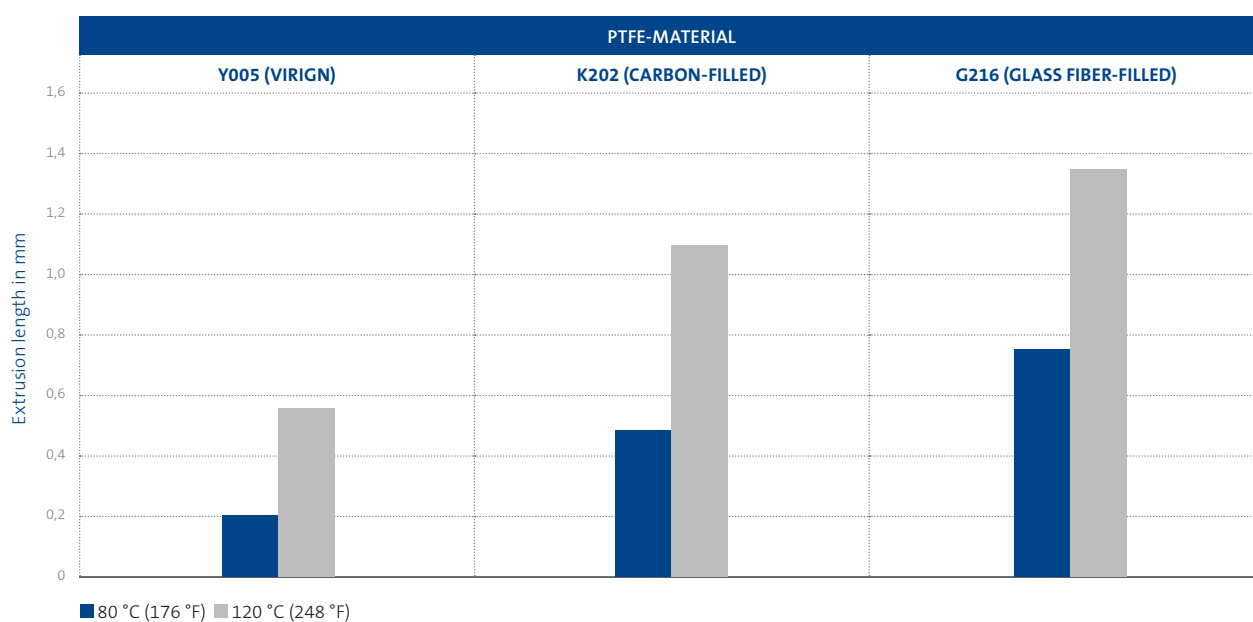

PTFE BELLOWS



Bellows are components which are primarily used to protect moving machine parts from external influences.

Wherever reciprocating mechanical parts need to be protected from environmental influences or aggressive media, bellows serve as reliable sealing components. They can also be used to compensate for movements, expansions, as well as axle offset, misalignments and vibrations. When used in combination with check valves, they can also be used to circulate or pump gases and liquids utilizing volume changes in the bellows, provided the installation space allows it.

Application range of bellows

- Virgin PTFE: Broad application range throughout the chemical industry
- Modified PTFE: Low-porosity variant for the food, beverage and pharmaceutical industries
- Conductive PTFE: Designed to prevent static electrical buildup
- Filled PTFE: Reinforcement with glass fibers or carbon fibers of those parts of the bellows under the most stress, e.g. where the bellows are mounted on a pump head

Function

- Protection of piston rods, linkages and other machine parts involving axial and in some cases radial motion
- Compensation of movements and displacements between two connecting components
- Circulation and pumping of gases and liquids using volume changes

Dimensions

- Smallest standardized internal diameter: 10 mm (smaller diameters available on request)
- Largest external diameter: theoretically unlimited

Installation and assembly

Please refer to page 94 for general installation and assembly instructions.

TYPES	
FBA-9000	Compensators for low pressures
FBC-9002	Compensators for moderate pressures
FV-series	Individual solutions for pump and valve bellows
FBAX-9001	Variant of FBA-9000 available on request, as well as an extensive range of customer-specific variants

Applications of bellows as compensators

- Compensation for expansion and vibration
- Compensation for axle offset, misalignments and displacements in pipes
- Fluid circulation in chemical, food and beverage industries
- Rod protection in chemical, food and beverage industries
- Protection from dust and contamination, e.g. for weighing equipment in filling plants

Applications of valve and pump bellows

- In feed pumps and metering pumps
- For control and shut-off valves in chemical, pharmaceutical and food and beverage industries

DESIGN NOTES	
Compensators	Standard bellows, as well as metal-reinforced special variants possible
Valve and pump bellows	Design guidelines based on individual experience in development and testing
Special installation notes	<ul style="list-style-type: none"> • The flange contact surfaces must be smooth and clean • PTFE bellows should not be over-expanded • PTFE flanges should be handled carefully due to their ductility • It may be advisable to use soft packings between flange and bellows • The screw holes and flange thickness listed for types FBA-9000 and FBC-9002 are smaller than those indicated in the DIN standard sheets

THE ADVANTAGES AT A GLANCE

- Highly resistant to nearly all chemicals
- Dependable sealing to prevent media contamination
- High cost effectiveness thanks to production by machining
- Special variants, made-to-order and small batches are possible
- Compensator bellows in nominal widths of DN 10 to DN 500 available in stock

PTFE U-PACKINGS



U-packings are unidirectional sealing elements with a U-shaped cross-section and a reinforcing metal spring which are used for sealing applications involving rotary or translatory motion.

PTFE U-packings are sealing components that enjoy a wide range of uses in the food and beverage industry, from ball valves to piston pumps. They are ideal for the sealing of pressures, as the system pressure amplifies their sealing function, as well as for aggressive media, thanks to PTFE's excellent media resistance.

PTFE U-packings contain a metal spring, which compensates for the loss of initial load caused by PTFE's tendency to creep. The contact pressure can be tailored to the parameters of the individual application scenario by means of u-, v- or o-shaped springs – open or crimped. PTFE U-packings are available as axial or radial sealing models for sealing applications involving translatory or rotary motion. Radial sealing models are available in inside and outside sealing versions.

Function

- Sealing of rotary and translatory motions
- Sealing of aggressive media and pressures

Dimensions

- Manufactured by machining, therefore available in nearly all dimensions
- Springs to match the dimensions are manufactured from endless material
- Standard dimensions (see types) available in stock

Installation and assembly

- Installation preferably without stretching or compressing of the rings. If stretching or compression is unavoidable, please consult Freudenberg. Lightly oil the rings prior to installation
- Please refer to page 94 for general installation and assembly instructions

Applications

- Ball valves
- Flanges and lids
- Swivel joints
- Distribution manifolds
- Hot water and steam valves
- Fittings
- Piston pumps
- Bearings

TYPES	
Axial sealing	<ul style="list-style-type: none"> • Variants with dynamic internal sealing lip for use as a rod seal: standard rod diameters from 10 to 200 mm • Variants with external sealing lip for use as a piston seal: standard piston diameters from 15 to 200 mm
Radial sealing	<ul style="list-style-type: none"> • With inward sealing function for use as a pressure seal (dimensions on request) • With outward sealing function for use as a vacuum seal (dimensions on request)
Spring types	<ul style="list-style-type: none"> • V-springs with a great degree of spring travel and soft spring characteristic for reduced friction, can be used for dynamic and static sealing and for rotation sealing • U-spring with a great degree of spring travel and higher spring rate for sealing of higher pressures • Round springs for high spring force with a lower degree of spring travel for sealing of extremely high pressures. Its special design distributes the spring load over a number of different sealing lips
Material variants	<ul style="list-style-type: none"> • Pure PTFE • PTFE with glass fibers • PTFE with carbon • PTFE with carbon fibers • PTFE with glass and/or molybdenum • PTFE with Ekonol • PTFE with aramid • UHMW PE (polyethylene) • PEEK

DESIGN NOTES	
Pressures	<ul style="list-style-type: none"> • Maximum permissible pressure for dynamic applications: 45 MPa • Maximum permissible pressure for static applications: 120 MPa • For 25 MPa or more, please consult Freudenberg, if necessary use backup rings
Lead-in chamfers	20° standard
Surface roughness	Sealing surfaces in accordance with the diagram <ul style="list-style-type: none"> • Lead-in chamfers <1.6 µm • Groove flanks <2.5 µm
Hardness	<ul style="list-style-type: none"> • Optimal running surface hardness 20 HRC to 65 HRC • Penetration depth min. 300 µm

THE ADVANTAGES AT A GLANCE

- Universal media resistance
- Broad temperature range
- Highly dependable
- Resistant to aging
- No stick-slip effect
- Special variants for higher pressures
- Special hygienic variants with minimal dead space

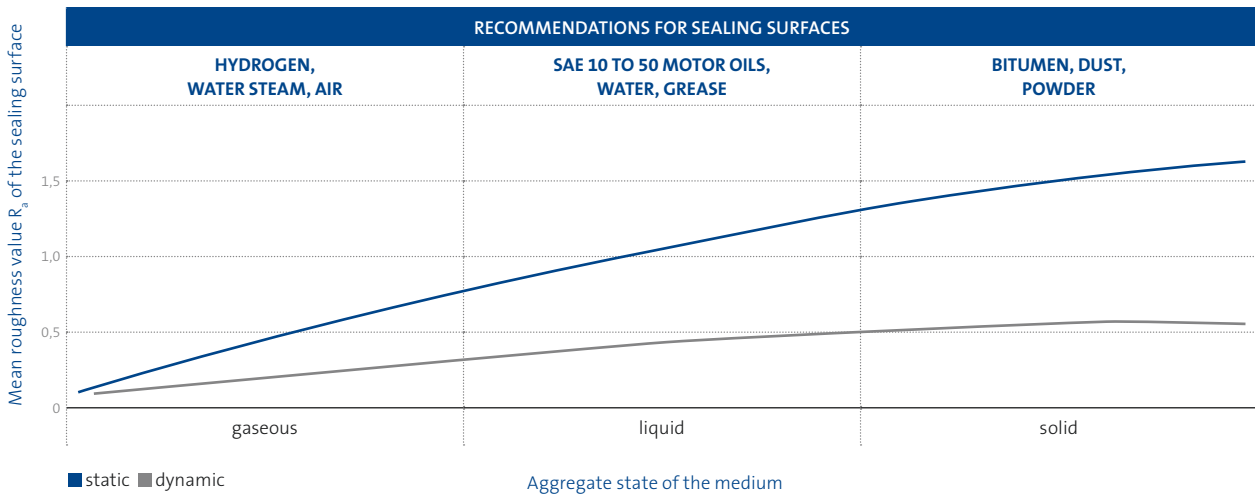

APPENDIX

LIST OF ABBREVIATIONS

ABBREVIATION	FULL NAME	DESCRIPTION
A		
ACN	Acrylnitril	The higher the ACN content of an NBR or HNBR elastomer, the better the resistance against non-polar media. The smaller the ACN content, the better the low-temperature flexibility. The ACN content ranges between 18% and 50%
ACS	Attestation de Conformité Sanitaire	French drinking water approval
ADI-free	Animal Derived Ingredient free	Assurance that no products derived from animals are used in manufacture
API	Active Pharmaceutical Ingredients	The pharmaceutically active ingredients in a medicinal product
ASME	American Society of Mechanical Engineers	United States platform for engineers and students
AWQC	Australian Water Quality Centre	Australian organization for drinking water standards
B		
BfR	Bundesinstitut für Risikobewertung	German Federal Office for Risk Assessment: BfR focusses on the assessment of risks in the field of consumer health protection and food and feed safety, e.g. BfR Recommendation 15 for silicones, BfR Recommendation / 21: Recommendation for articles of daily use based on natural and synthetic rubber material for silicone material/rubber in food use
C		
CIP	Cleaning In Place	Cleaning processes in closed plants of the process industry, without disassembly
CNC	Computerized Numerical Control	Method in machining technology
COP	Cleaning Out of Place	Cleaning method in the process industry with disassembly
D		
DIN	Deutsches Institut für Normung	German institute for standardization
DM	Dachmanschetten	Rod seal set consisting of roof-shaped seals and supporting rings
DN	Diameter nominal	Nominal diameter, e.g. for pipes
DVGW	Deutscher Verein des Gas- und Wasserfaches	German Technical and Scientific Association for Gas and Water
DVR	Druckverformungsrest	Compression set, a mechanical performance parameter for elastomers. The compression set describes the ability of a material to generate a sufficient restoring force on the sealing surfaces and thus ensure the tightness, even after a certain contact time with the media in question
E		
EDTA	Ethylene-diamine-tetra-acetic-acid	
EHEDG	European Hygienic Engineering & Design Group	Consortium of plant engineers and operators in the food and pharmaceuticals industries
EPDM	Ethylene-Propylene-Diene-Rubber	A base elastomer
ePTFE	Expanded PTFE	In a special process, the molecular chains of ultra-thin PTFE layers are stretched, these layers are stacked multi-directionally and loosely pressed. As a result, the cold flow is optimized, the seals are very adaptable and meet, after pressing on site, the highest leak tightness requirements, e.g. according to TA Luft
ETA-DK	European Technical Approvals – Denmark	Danish organization for issues concerning drinking water
EU Reg.	Regulation of the European Union	A regulation is a legally binding act (directive) which all EU countries must fully implement
F		
FB	Faltenbalg	Bellow
FDA	Food and Drug Administration	A federal body in the United States responsible for the regulation of medications and pharmaceuticals, part of the United States Department of Health and Human Services
FEM	Finite-Elemente-Methode	A calculation method used to determine forces and loads in components
FEP	Fluorinated-Ethylene-Propylene	A thermoplastic material used as a material for encapsulation of O-rings
FFKM	Perfluoroelastomer	A base elastomer
FKM	Fluoroelastomer	A base elastomer
G		
GC	Gas chromatography	Analytical method for mixtures which can be converted into the gaseous phase and can then be separated and detected
GMB	Elastomer diaphragm with fabric	Elastomer diaphragm with fabric
GMBM	Elastomer diaphragm with metal insert and fabric/film	Elastomer diaphragm with metal insert and fabric/film
H		
HNBR	Hydrogenated-Nitrile-Butadiene-Rubber	A base elastomer
HRC	Hardness Rockwell C	Rockwell hardness test with scale C (for materials with a high hardness)
HTS II	High Temperature and Speed	Rotary shaft seal

ABBREVIATION	FULL NAME	DESCRIPTION
I		
IRHD	International Rubber Hardness Degree	Measure of the hardness of an elastomeric material, especially in case of small cord sizes, German term also “microhardness determination”
ISBT	International Society for Beverage Technologists	United States organization for the beverage industry
ISO	International Organization for Standardization	
ISPE	International Society for Pharmaceutical Engineering	International industry association for the pharmaceutical industry
K		
KIWA	Ministerial Expert Committee + Toxicity Subcommittee	Directive from the Netherlands
KTW	Kunststoffe im Trinkwasser	Plastics in drinking water: a German norm for the use of plastics and elastomers in drinking water facilities
M		
MB	Membran	Elastomer diaphragm
MBM	Elastomermembran mit Metalleinlage	Elastomer diaphragm with metal inserts
MRO	Maintenance, Repair and Operations	
MS	Mass spectrometry	Analysis method to separate particles according to their mass and to identify them hereby
N		
NBR	Acrylo-Nitrile-Butadiene-Rubber	A base elastomer
NSF	National Sanitation Foundation	The NSF defines standards for applications in the food industry (NSF 51) and drinking water applications (NSF 61)
O		
OEM	Original Equipment Manufacturer	
OML	Overall Migration Limit	Total amount of substances escaping from a sealing material under certain test conditions (EU Reg. 10/2011)
OPC	Open Plant Cleaning	A cleaning method used in the process industry
ÖVGW	Österreichischer Verein des Gas- und Wasserfaches	Austrian Gas and Water Union
P		
PA	Polyamide	A thermoplastic
PE	Polyethylene	A thermoplastic
PEEK	Polyetheretherketone	A thermoplastic
PFA	Perfluoralkoxy Copolymer	A thermoplastic
POM	Polyoxymethylene	A thermoplastic
PTFE	Polytetrafluoroethylene	A thermoplastic
PU	Polyurethane	A thermoplastic
R		
RFN	Reduced Friction by Nanotechnology	A patented Freudenberg method for reducing friction in elastomer seals
RWDR	Radialwellendichtring	Rotary shaft seal
S		
safe	secure adaptive freudenberg encryption	A product marking technology ensuring reliable identification
SIP	Sterilization In Place	A sterilization method used in the process industry
SML	Specific Migration Limit	Migration value of a single substance in tests according to EU Reg. 10/2011, see also OML
T		
TOC	Total Organic Carbon	Sum parameter for the carbon content in water and wastewater analysis
U		
USP	United States Pharmacopeia	Collection of recognized pharmaceutical rules originating in the USA
V		
VDMA	Verein Deutscher Maschinen- und Anlagenbau	German Engineering Federation: a German industrial association
VMQ	Vinyl-Methyl-Polysiloxane	A base elastomer, silicone
W		
W 270	Part of KTW testing	W 270 is concerned with the “propagation of microorganisms on materials used in drinking water applications – testing and assessment“
WDR	Wellendichtring	Shaft seals
WIP	Washing In Place	A cleaning method used in the process industries
WOP	Washing Out of Place	A cleaning method used in the process industries
WRAS	Water Regulations Advisory Scheme	A standard / An organization responsible for the approval of machinery used in drinking water plants (Great Britain)

GENERAL INSTALLATION AND ASSEMBLY INSTRUCTIONS

GENERAL INSTALLATION AND ASSEMBLY INSTRUCTIONS	
Cleanliness	For all types of seals, it is imperative that both the installation space and the seal itself are clean. Metallic processing residues, such as particles and cuttings, are particularly dangerous
Sealing surfaces	The sealing surfaces must at least have the surface roughness indicated in the catalogs. Check for scratches, gouges and cavities
Surrounding area	If seals have to be stretched and pushed over sharp edges or threaded surfaces during installation, these should be rounded off or covered with protective sleeves
Storage conditions	Prior to installation, ensure that the seal was properly stored. If the seal is individually wrapped, do not remove it from its package until you are ready to install it (see page 25)
Assembly aids	It is always important to ensure that mounting tools and other aids do not damage the seal or the installation space. Installation sleeves, expansion mandrels, chamfers on pistons and cylinders and rounded brass pins are well-suited. A screwdriver is not a suitable assembly tool
Lubricants	If the use of lubricants is required for assembly or installation, it must be verified whether the seal material is resistant to the lubricant
Positioning	For many seals (e.g. U-packings and radial shaft seals), it is important to install them with the correct positioning/ in the correct direction

LEGAL NOTICES

The contents of this handbook have been carefully prepared. The information is based on our decades of research into the development and manufacture of sealing solutions as part of the Freudenberg Group and reflects our current state of knowledge. However, as seal performance is not only dependent on the seal itself, but also on various other parameters connected to the individual application, which are beyond our control, we do not assume any liability for the statements made in this document.

As such, the information contained in this handbook can provide only general and non-binding guidelines. We recommend that you discuss specific, individual applications with our technical consultants as a matter of principle.

All rights, in particular to texts, images and other work protected by copyright and published in the handbook, are reserved by Freudenberg. Any reproduction, distribution, transmission, and other utilization of the contents without written permission is expressly prohibited.

Editorial Information

Freudenberg

Freudenberg Sealing Technologies

Freudenberg Process Seals GmbH & Co. KG

Lorscher Straße 13

69469 Weinheim, Germany

Phone: +49 (0) 6201 80 8919-00

Fax: +49 (0) 6201 88 8919-69

E-Mail: fps@fst.com

www.fst.com

2016